

HIT

Innovations and hot deals.
2018 EN. 



High quality hand tools and more since 1900.



Be a MATADOR.



MATADOR is one of the **pioneers in the tool industry**. Since **1900** we have been producing **quality hand tools** „around the screw“ in Remscheid, the German capital of the tools industry. Our core competences are spanners, sockets, torque and pneumatic tools as well as modules for workshops. **For all kind of screws from 3.2 to 230 mm**. 4,500 catalogue articles. Tried and tested a million times. Available in >70 countries. For ambitious users in industry, trade and the automotive industry. MATADOR is an **accredited supplier of all major OEMs** like Audi, Bosch, Ford, MAN, Mercedes-Benz, Volkswagen, Volvo, etc.

Beyond the ordinary.

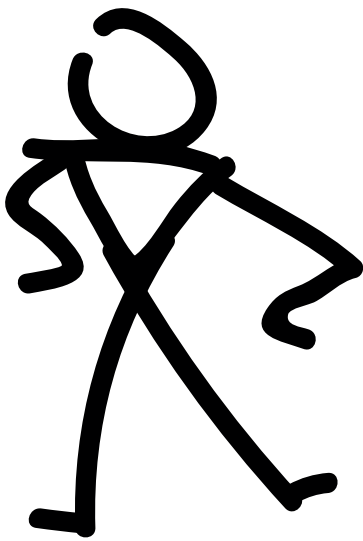

MATADOR is **the opposite of mainstream**. We stand for upmarket premium tools. Reliable, design-focused, efficient. Intelligent tightening tools made for decision makers, fighters and **everyday heroes**. For real MATADORS.

For people who know and express what they want. People **who are inside the arena**, not in the stands. Who know **the difference between tools and toys**. Who do not seek excuses and are true to themselves. Past and present. For down-to-earth, straightforward and assertive individuals with life experience and stories to tell. Who overcome adversity, manage a healthy work-life balance and **believe in themselves**. Who appreciate the exceptional and own pretty things. Who do not hesitate to show that. For people who have fun and enjoy life. Welcome to the arena.

Be a MATADOR.



Screw IT!

■ Screw Extractor

Loosens nearly all damaged, unhardened and even rusty screws without thread repair tools. **The problem:** Screws of low quality are used more and more. **The consequence:** Damaged and rounded screw heads are no longer an exception. Even the best screwdriver will be of no use. The screw cannot be loosened. **The solution:** In most cases the screw can be loosened without employing laborious threading tools: Simply drive the tip of the the **MATADOR ScrewIT!** down into the screw head by using a hammer, then unscrew the screw - done!

ART. CODE
0770 0002

10,95 €

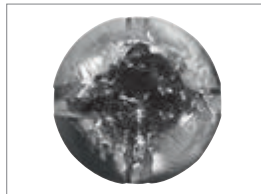

Perfect for rounded or rusted screw heads.



With injected impact cap.

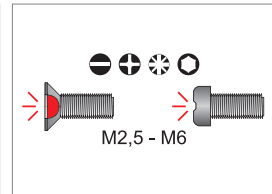

For all threads from M2,5 - M6.

Content:

	Page
Screw Extractor ScewIT!	4
The Boss. The new Z90.	5-11
smartyBOX	12-15
Torque wrenches UNO	16-17
Digital torque wrenches	18-19
Tools trolley RATIO	20-21
RATIO unlimited edition	22-25
Trolleys, fully equipped	26-29
Single modules for tools	30-35
Cubes - The smart tool sets	36-41
HITdeals - Our Topsellers	42-53
Pneumatic tools	54-55
Pliers 3C	56-57
Bench vices	58
Tool cases	59-61
VDE tools	62-63
Men`s Kitchen®	64-74
Tool trolley ALLROUND	75

It's time for something new.



1919.
The first lever ratchet.



2018.
The Boss. The new **Z90**.

It takes something more to make a really good ratchet.

More teeth. More power. More grip. More applications. More design.



25%

reduced angle (only 4°) compared to standard fine-toothed ratchets thanks to an **innovative 90-teeth technique**. Still ready for working even when it gets really tight.

50%

more torque than requested in the DIN standard (e.g. 12.5 mm (1/2") > 750 N·m). Still loosens screws when others have long given up.



Push-button lock for a safe connection between ratchet and socket.

Recessed, **flat lever** for quick change of direction.

Extremely robust square shank made of **Chrome Vanadium steel** for high resilience in every situation.

Extremely fine toothed, extremely strong, extremely ergonomic.

Since the presentation of **the first reversible ratchet back in 1919** MATADOR has been intensively dealing with drive technology. MATADOR ratchets have been developed for professional users. They are proven **millions of times** and **well-known for their solid workmanship and durability**. But what features must the ideal 21st century ratchet have?

We thought a lot about how we can stay true to our line and at the same time create an innovative, real master piece.

The result is our new „Boss“: the **Z90**. **Aggressive in appearance, outstanding in function, with a rich sound and uniquely ergonomic**. With the new **Z90** every screwing task becomes an experience.

The **Z90** has a little more of everything. **More torque** (50% more than requested in the DIN standard), **more teeth** (25% than standard fine-toothed ratchets), **more applications** thanks to its especially small swivel angle of only 4°, **more grip** with its ergonomic, hand-friendly handle made of several components and last but not least: **More Design**.

No frills but classic in shape and **with aggressive details**. Made of high-alloyed chrome vanadium steel and fully CNC machined the **Z90** stands for precise production competence. Tested for at least **30,000 tightening cycles** it is made for the long haul - just a typical MATADOR.

Light grey, soft zone made of TPE plastic, especially anti-slip, for good grip and a comfortable support to the fingers.

Medium grey, nubby zone made of TPE plastic, large area for non-slip grip and transmission of high powers.

Black, hard zone made of special plastic for quick gripping without sticking.



Ergonomic and comfortable **thumb rest**.

max.

ergonomics thanks to multi-component handle, better than standard 1- or 2-component handles. Optimally adapted, spherical shape.

Practical **hanging loop** to secure the ratchet during construction work or to hang on a tools panel.

Outstanding technical features.
Developed for the long haul.



Torque test:

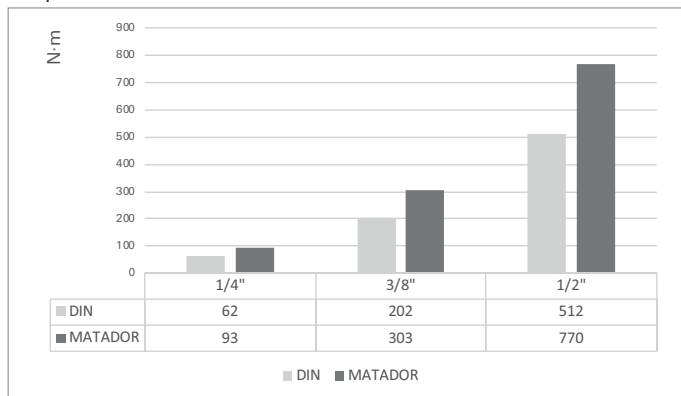

Torque test with 10 ratchets each type, tightening up to 50% above DIN standards. Outcome: No deformation, no restrictions.

Life cycle test:

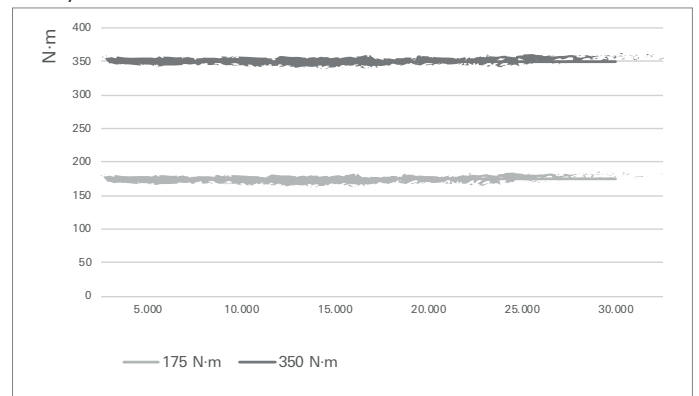

Life cycle test: 1/2" ratchet with 30,000 loading cycles at 175 N-m and 350 N-m permanent load. Outcome: No wear and tear.

Perfect ergonomics.
Sometimes it's hard to let go.



Powerful.



2x4 double pawl for maximum power development.

Comfortable.



Completely new developed multi-component handle.

Practical.



Practical hanging hole for securing the tool.

Safe.



Push-button lock for safe working.

Economic.

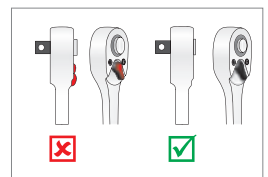

Recessed lever for low wear.

3 sizes - from ultra compact to really powerful.
Perfect dimensions.

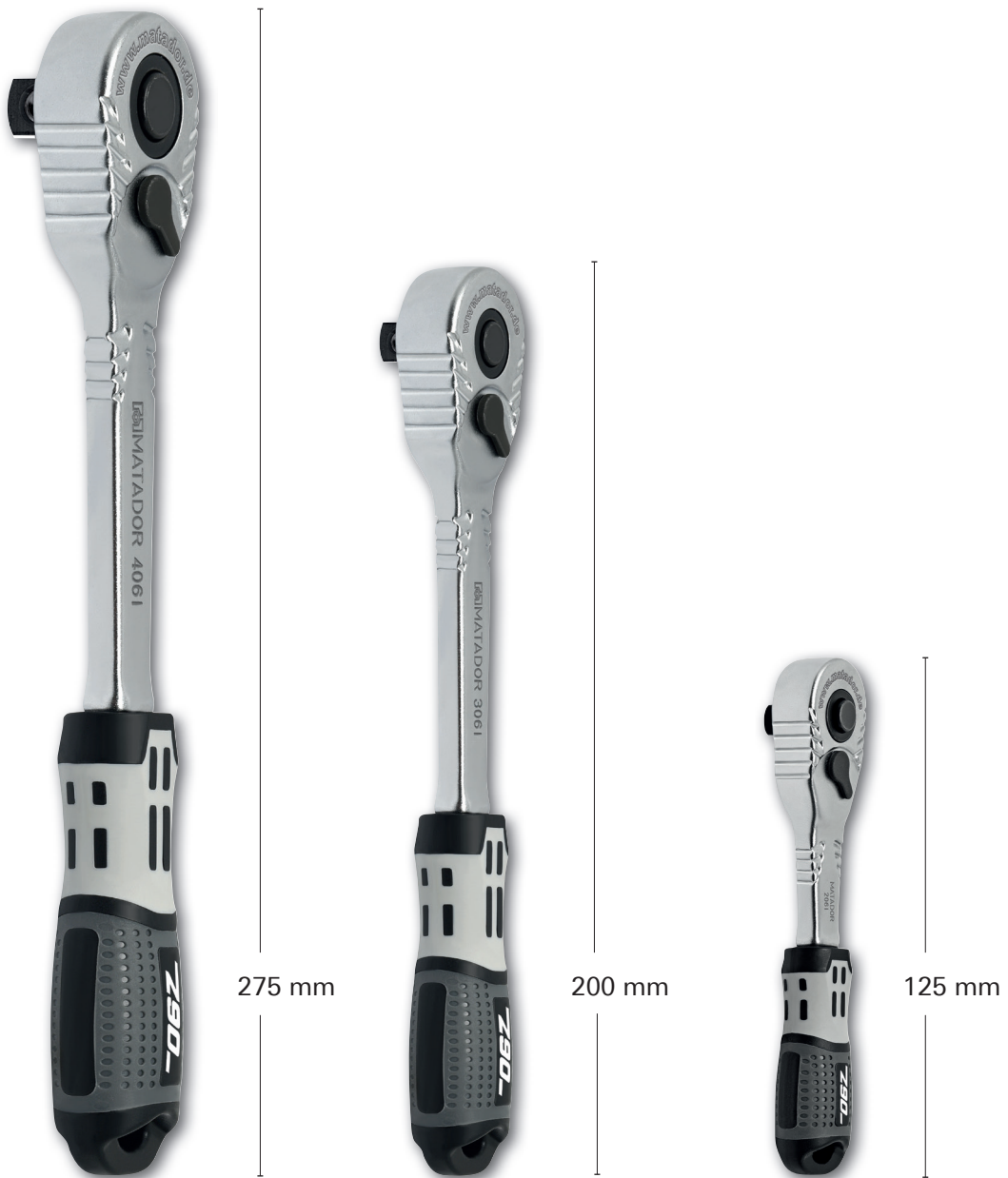

Just exchange your old one.

Available as a single tool or in a double or triple pack.

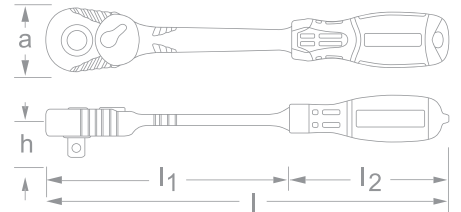

■ Ratchet

1/4



°	l mm	l1 mm	l2 mm	a mm	b mm	g
4	125	70	55	23,5	24,7	112

ART. CODE
2061 0090

28.95 €

■ Ratchet

3/8



°	l mm	l1 mm	l2 mm	a mm	b mm	g
4	200	120	80	29,1	32,8	234

ART. CODE
3061 0090

34.95 €

■ Ratchet

1/2



°	l mm	l1 mm	l2 mm	a mm	b mm	g
4	275	165	110	37,7	42,2	539

ART. CODE
4061 0090

38.95 €

■ Lanyard / Security belt



With carabiner. Fits all ratchets.

ART. CODE
8191 0107

2.48 €

■ Ratchets Double Pack



Two is better.
Set with 1/4" and 1/2" ratchet.

6.3 1/4 12.5 1/2

ART. CODE
4061 0092

64.95 €

■ Ratchets Triple Pack



All good things come in threes.
Set with 1/4", 3/8" and 1/2" ratchet.

6.3 1/4 10 3/8 12.5 1/2

ART. CODE
4061 0093

94.95 €

The new smartyBOX.

Intelligent tools ultra-compact.



Folding plastic handle.

Stackable and can be clicked onto each other for easy transport.

Corrosion-free, robust, stable, shockproof, dustproof, versatile, food-safe.

Compact in size:
W 206 x D 156 x H 63 mm.

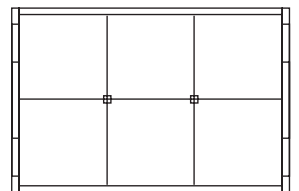

Based on L-BOXX[®]-Mini, the L-BOXX[®] system by Bosch and Sortimo with numerous extension and combination possibilities.

smartyBOX empty, black, with dividers for up to 6 compartments
ART. CODE
8145 0020 **7.95 €**



Intelligent tools with numerous additional features in a versatile transport box - that is the concept of the **MATADOR smartyBOX**.

Small, compact, stackable and can be clicked onto each other for convenient transport. Thus you always have your most needed tools directly available on site.

Every smartyBOX covers a specific purpose:

The 61-pc set **S1 is a universal box** including the most important tools for small and bigger repairs at work, at home and for hobby. The new **90-teeth reversible ratchet 790** allows you to work even in the narrowest spaces. With the new MATADOR spinner handle you can create up to **30 different screwdriver combinations**. Thanks to all the adapters included a **blade length of up to 320 mm** can be reached. Together with the **innovative combination pliers** with **3KsoftGRIP** handle the S1 becomes a really intelligent allround set.

The **S2 is the perfect compact set** for all bigger screwing tasks from **6 - 22 mm**. Thanks to the handy **3/8" drive of the new 90-teeth ratchet 790** and together with the **8° swiveling extension bars** you do no longer need to worry about hard-to-reach areas. If more power is required especially **high torque values (up to 50% above DIN standard)** prove their advantage. The **adjustable wrench helps countering nuts** or whenever bolts and cables require an open ended wrench.

Finally, the **S3 is the perfect completion** to the smartyBOX series: Slightly angled combination **ratchet spanners from 7 to 19 mm with lever** and patented gear do your job quickly and safely. Thanks to the **additional ratchet adapters** the ratchet spanners can be used as operating tools for sockets.

The smartyBOX - really smart.



Sometimes the length is crucial.

With the new MATADOR spinner handle you are definitely flexible.

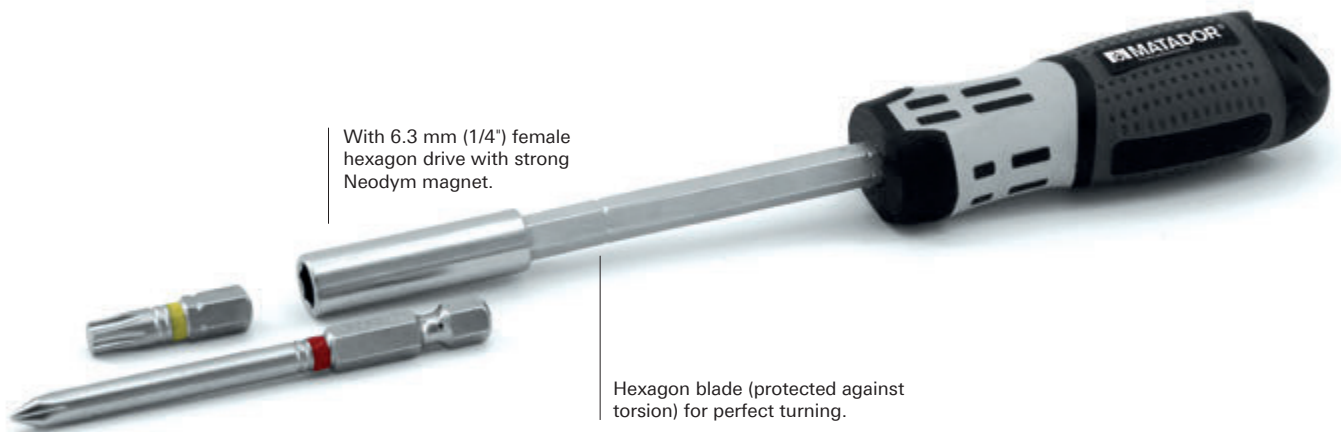

With 6.3 mm (1/4") female hexagon drive with strong Neodym magnet.

Hexagon blade (protected against torsion) for perfect turning.

Extendable from 110 mm up to 320 mm.
When length counts.

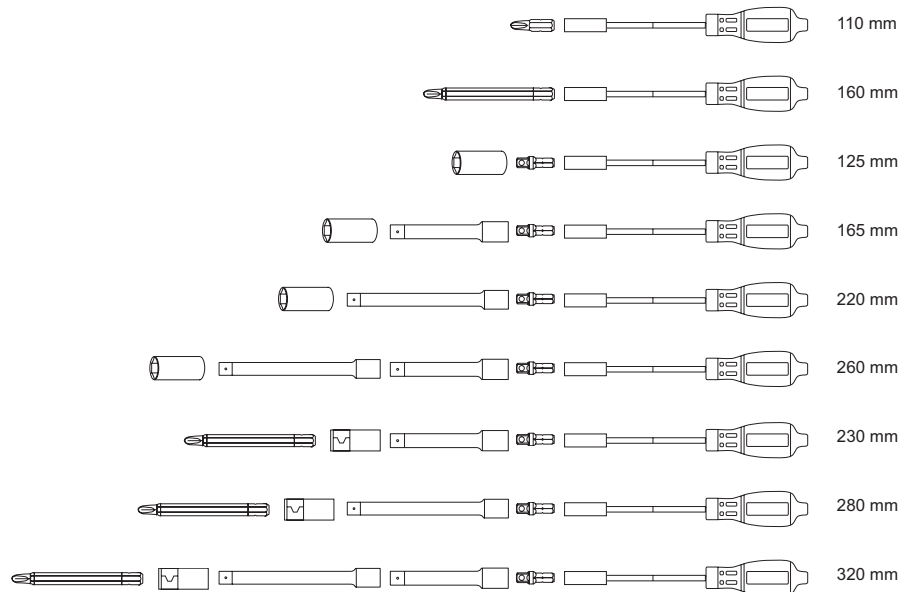

■ **smartyBOX, 61 pcs**
S1 - Universal



Ultra-handly **universal box** including the new **790** MATADOR 1/4" reversible ratchet.

The absolute full equipment for screw tasks from **4 - 14 mm**, including **combination pliers with integrated ring spanner** for countering. With **innovative spinner handle** that can be used as a **multiscrewdriver** and extended to a total length of 320 mm.

Content:

	3K 0500 3C Combination Pliers 160 mm
	0500 Retaining Clip for Combination Pliers
	6.3 1/4 2061 Reversible Ratchet
	6.3 1/4 2064 Sliding T-Handle 115 mm
	6.3 1/4 2065 Extensions 50 - 100 mm
	6.3 1/4 2068 Universal Joint
	6.3 1/4 2073 Multi Component Spinner Handle
	6.3 1/4 2075 4 - 4.5 - 5 - 5.5 - 6 - 7 - 8 - 9 - 10 - 11 - 12 - 13 - 14 mm
	6.3 1/4 2084 Bit-Adapter F
	6.3 1/4 2084 Bit-Adapter M
	6.3 1/4 2085 Drill Adapter for Sockets
	6.3 1/4 7040 Drill Adapter for Bits
	6.3 1/4 7026 Bits 3 - 3.5 - 4.5 - 5.5 - 6.5 x 25 mm Screwdriver-Bits long type: 4 - 6 x 75
	6.3 1/4 7027 Bits PH 0 - PH 1 - PH 2 - PH 2 - PH 3 x 25 mm Screwdriver-Bits long type: PH 1 - PH 2 x 75
	6.3 1/4 7027 Bits PZ 0 - PZ 1 - PZ 2 - PZ 2 - PZ 3 x 25 mm
	6.3 1/4 7028 Bits 3 - 4 - 5 - 6 x 25 mm
	6.3 1/4 7033 Bits T6 - T7 - T8 - T9 - T10 - T15 T20 - T25 - T27 T30 - T40 x 25 mm Screwdriver-Bits long type: T25 - T30 x 75
	8191 Lanyard with snap hook for securing the reversible ratchet

ART. CODE **8145 2115** **61** **99.95 €**

■ **smartyBOX, 25 pcs**
S2 - Compact



Comprehensive socket set with the new MATADOR 3/8" reversible ratchet **790**.

Covers 90 % of all screw tasks with socket sizes from **6 - 22 mm**. **8° swivelling extension bars** included for screw connections that are difficult to reach. With **adjustable wrench**, perfect for countering or screw tasks that require an open ended spanner (e.g. when bolts are in the way).

Content:

	0591 Adjustable Wrench 1-20 mm (8")
	10 3/8 3061 3061 Reversible Ratchet
	10 3/8 3065 Swivelling Extension Bars 75 - 125 mm
	10 3/8 3068 Universal Joint
	10 3/8 3075 6 - 7 - 8 - 9 - 10 - 11 - 12 - 13 - 14 - 15 - 16 - 17 - 18 - 19 - 20 - 21 - 22 mm
	10 3/8 3084 Bit-Adapter F
	10 3/8 2085 Drill Adapter for Sockets
	8191 Lanyard with snap hook for securing the reversible ratchet

ART. CODE **8145 3115** **25** **109.95 €**

■ **smartyBOX, 12 pcs**
S3 - Completion



Innovative completion box with combination ratchet spanners and ratchet adapters.

Combination ratchet spanners **with lever** for quick change of direction. With slightly angled ring side. Includes the most important **spanner sizes from 7-19 mm** and **4 additional ratchet adapters** for using the ratchet spanners as a full-value ratchet for sockets.

Content:

	0189 7 - 8 - 10 - 12 - 13 - 15 - 17 - 19 mm
	0186 Bit Adapter for Combination Ratchet Spanners SW 10
	0186 Ratchet Adapter for Combination Ratchet Spanners SW 10
	0186 Ratchet Adapter for Combination Ratchet Spanners SW 13
	0186 Ratchet Adapter for Combination Ratchet Spanners SW 19

ART. CODE **8145 0189** **12** **119.95 €**

Torque wrenches UNO.

One window. One value. One grip. One click.



Make complicated things simple.



Easy setting at the end of the handle.



Only one window with clear numeric value in N·m.



Error-free handling thanks to double-sided finger grooves.



Integrated lever ratchet with small head to reach tiny areas.



Well protected in solid plastic case.

Extremely precise and easy to use.

The new professional torque wrench by MATADOR with an **absolutely innovative operating concept**:

Easy setting with extra fine graduation (from 0.5 N·m to 1.0 N·m on larger models), **only one window with clear numeric value in N·m**. No division scale which is difficult to read.

With small ratchet head to reach tiny spaces, with lever and 48 teeth, safety lock and quick-release function. Permanent protection of the body thanks to full powder coating.

The handy and ergonomically optimal design of the handle with its integrated finger grooves make the correct use a breeze. Clearly audible and perceptible signal when the desired torque value is reached.

The MATADOR UNO is extremely precise: **maximum deviation only ±3%** from the set scale value. For controlled clockwise operation. With German calibration certificate according to DIN EN ISO 6789.

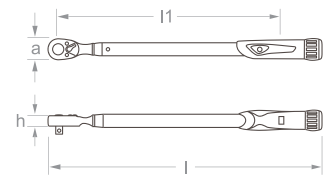

From 5 - 1,000 N·m.
For industry and automotive.

ART. CODE	mm / °	N·m	l1 mm	a mm	h mm	l mm	g	
6175 0025	6.3 mm / 1/4	5 - 25	250	22.5	19.6	343	760	119.- €
6175 0050	10 mm / 3/8	10 - 50	322	31.2	26.7	419	983	129.- €
6175 0100	12.5 mm / 1/2	20 - 100	337	41.0	36.4	419	998	129.- €
6175 0200	12.5 mm / 1/2	40 - 200	435	41.0	36.4	435	1360	139.- €
6175 0340	12.5 mm / 1/2	68 - 340	538	41.0	36.4	640	1730	149.- €
6175 0550	20 mm / 3/4	110 - 550	827	58.0	55.0	938	1784	399.- €
6175 0750	20 mm / 3/4	150 - 750	1107	58.0	55.0	1218	5850	499.- €
6175 1000	25 mm / 1	200 - 1000	1393	67.0	67.0	1508	7426	599.- €
6175 5050	9x12 mm	10 - 50	322	31.2	26.7	419	886	129.- €
6175 5100	9x12 mm	20 - 100	337	41.0	36.4	419	886	129.- €
6175 5200	14x18 mm	40 - 200	435	41.0	36.4	435	1180	139.- €
6175 5340	14x18 mm	68 - 340	538	41.0	36.4	640	1554	149.- €

Digital torque wrenches.

For torque and torque angle configurations. Better safe than sorry.

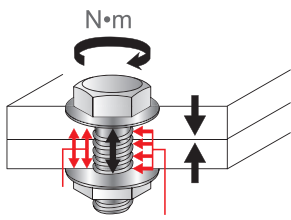

For measuring torque and torque angle.

±2% ±1%

10 - 1,000 N·m

Stores up to 900 results and up to 30 different configurations.



With 9x12 or 14x18 mm rectangular cavity including MATADOR insert ratchet.

Models 160 - 800 N·m and 200 - 1,000 N·m with permanently integrated lever ratchet.



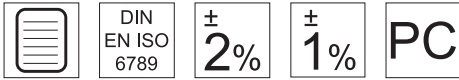

Ergonomically shaped, rubber coated handle for easy grip.

Large LCD display with high contrast for easy reading from any position.

Only 4 function keys, all functions can be set directly in the wrench without external device (like PC), very easy set-up.

Indicating, digital torque wrench, with or without angle function.

- For clockwise and anti-clockwise readings
- Accuracy $\pm 2\%$ (torque) and $\pm 1\%$ (angle) of the set scale value. ($\pm 1\%/\pm 1\%$ on request)
- Precise reading accuracy for a minimum of 10,000 tightening cycles
- With 3 optical LEDs and acoustic signal with buzzer (pre-warning = yellow, ok = green, not ok = red)
- Very compact design with in-handle LCD-Display (132 x 32 Pixel)
- Protected display with backlight
- „Peak hold“ and „Track“ modes
- With 9x12 or 14x18 mm rectangular cavity (models 160 - 800 N-m and 200 - 1,000 N-m with integrated lever ratchet)
- N-m, kg, lbf-in and lbf-ft.
- Individual programming of 30 different torque configurations and memory space for up to 900 tightening cycles
- Adjustable torque tolerance range
- Adjustable Auto-Off
- Password protection against accidental readjustment or unauthorized access
- Different selectable languages (G, E, I)
- Display of clock and battery status
- Only 4 function keys for easy access
- Easy access to all functions directly at the wrench, no computer configuration necessary
- Ergonomic, rubberized handle
- Data output RJ 45 with optional USB data transfer kit
- Including insert ratchet (up to 350 N-m)
- Including 4 x AA-1,5V batteries for long power
- With individual serial number and calibration certificate according to DIN EN ISO 6789 on which the accuracy is documented
- Delivered in solid plastic case with detailed instruction manual
- Optional readout software „EasyReport“ for saving all data to PC, with USB cable



Acoustic and optical signal through 3 LEDs with traffic light function.



Simultaneous display of torque and angle.



Well protected in valuable transport case.

mm / °	N-m	lbf-in	lbf-ft	mm	l mm	g	
6.3 mm	1/4	10 - 50	88 - 443	7,38 - 36,9	9x12 mm	357	1150
12.5 mm	1/2	20 - 100	177 - 886	14,8 - 73,8	9x12 mm	418	1360
12.5 mm	1/2	40 - 200	354 - 1770	29,5 - 147,5	14x18 mm	512	1430
12.5 mm	1/2	70 - 350	619 - 3098	51,6 - 258,1	14x18 mm	610	1550
20 mm	3/4	160 - 800	1416 - 7080	118 - 590,0	--	1100	4400
25 mm	1	200 - 1000	1770 - 8850	147,5 - 737,6	--	1340	6600

Readout software including USB data transfer cable

without angle function, precision $\pm 2\%$	
ART. CODE	
6178 0052	698.- €
6178 0102	698.- €
6178 0202	848.- €
6178 0352	848.- €
6178 0802	1,998.- €
6178 1002	2,098.- €
6178 9996	99.- €

with angle function, precision $\pm 2\%$ / $\pm 1\%$	
ART. CODE	
6178 1052	948.- €
6178 1102	948.- €
6178 1202	998.- €
6178 1352	998.- €
6178 1802	2,598.- €
6178 1112	2,698.- €
6178 9996	99.- €

Tool trolley **RATIO**.

One for everything. 7 or 8 drawers. Spacious, solid and loadable.



Our topseller **RATIO** now **with 7 or 8 drawers** with highly resistant powder coating (**black**, RAL 9005), drawer handles made of aluminium.

Comfortable working height (1,030 mm), **durable ABS worktop** with several compartments for small parts and holders for tins. Ergonomic handle for convenient pushing, pulling and turning even when fully loaded. **Rounded edges** and **integrated corner damage protection**. Both side panels with **square perforation** for assembly of accessories. Ball-bearing castors with high loading capacity (500 kg in total).

Drawers with **3-level locking system**: central locking, single-locked drawers, mechanical interlock („one at-a-time“ locking system). **Fully extendable drawers** (real 100%) with ball-bearing high performance slides. Including **pictogram labels** for individual drawer labelling and quick orientation.



Full extension drawers (100%), loading capacity up to 40 kg per drawer.



Durable ABS worktop with several compartments for small parts.



Individual aluminium name tag on request.



With 7 or 8 drawers.

■ Tool trolley **RATIO** with 7 drawers

Internal dimensions of drawers:

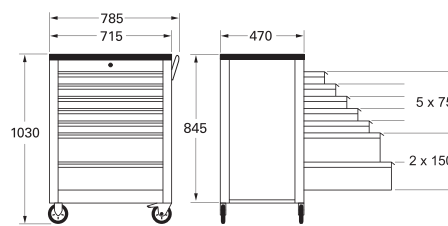
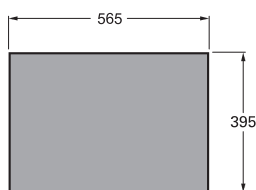

Tool trolley without tools and accessories.



■ Tool trolley **RATIO** with 8 drawers

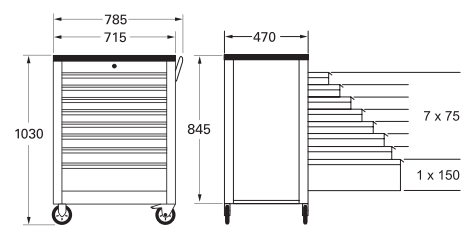

Tool trolley without tools and accessories.



For more tool trolleys please refer to our 450-page main catalogue.

ART. CODE **8163 0020** **499.- €**

ART. CODE **8163 0030** **599.- €**

The perfect workstation. No need to be modest in terms of space.

Our tool chests **RATIO** now **with 3 drawers or with 3 large and 3 small drawers**. All drawers 100% extendable, loadable with 40 kg each. **Ergonomic handle** and **central locking with cylinder lock**.



100% full extension, loading capacity up to 40 kg per drawer.



Side and back panels with square perforation for accessories.



Tool chest for the tool trolley RATIO.



Also stackable for even more space.

■ Tool Chest RATIO +3 with 3 drawers

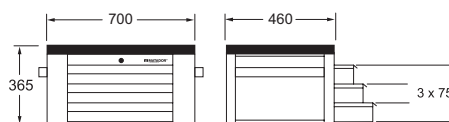

Tool chest without tools and accessories.

22 kg

ART. CODE **8163 0019** **249.- €**

■ Tool Chest RATIO +6 with 3+3 drawers

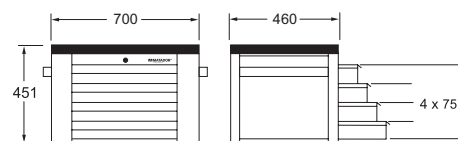

Tool chest without tools and accessories.

29 kg

ART. CODE **8163 0018** **349.- €**

For more details:

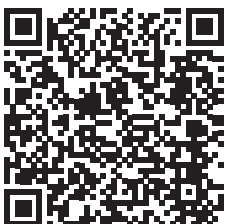

MTS unlimited edition.
350 high quality tools. 8 modules. That's it.

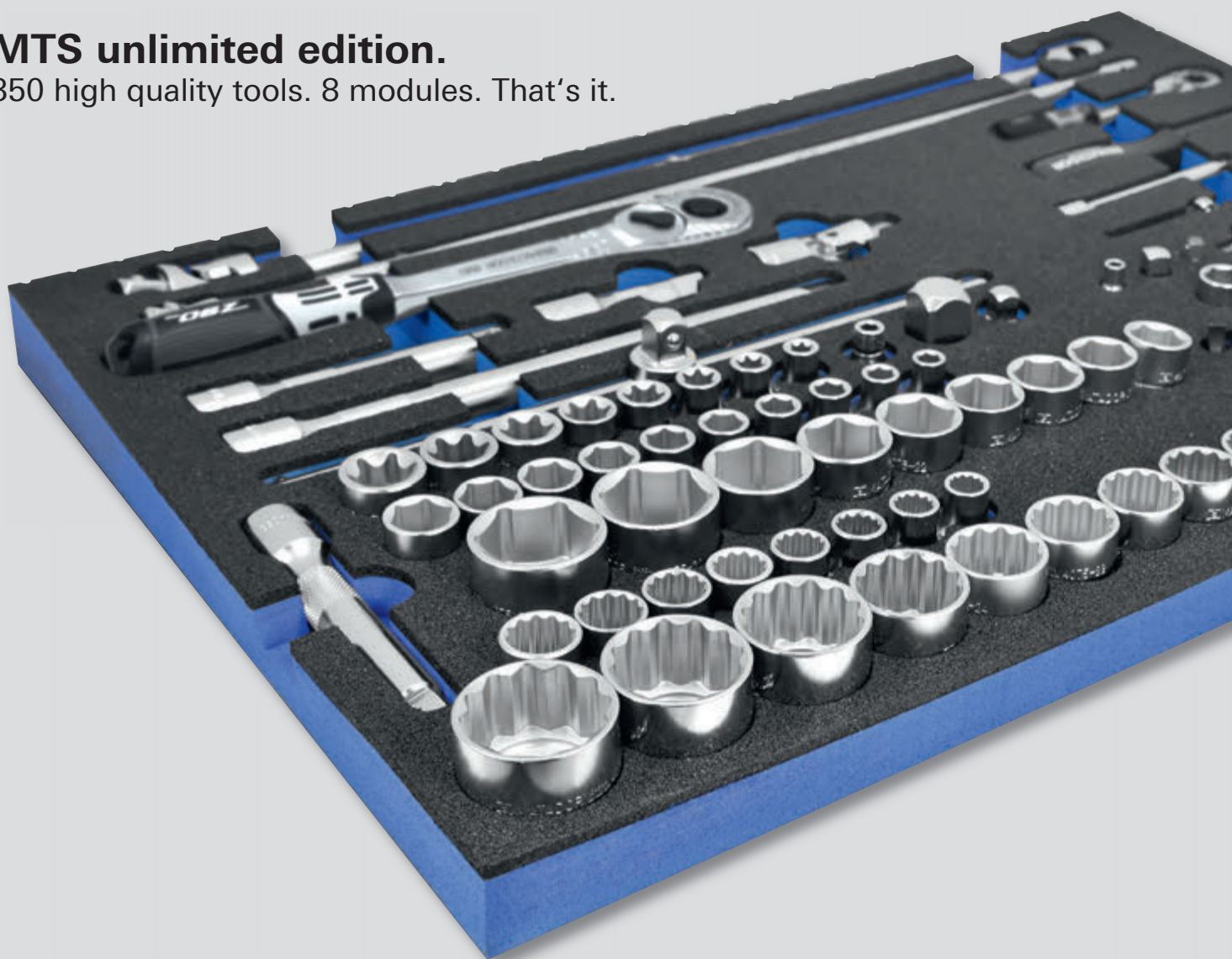

MTS

unlimited edition

Focusing on the essentials.

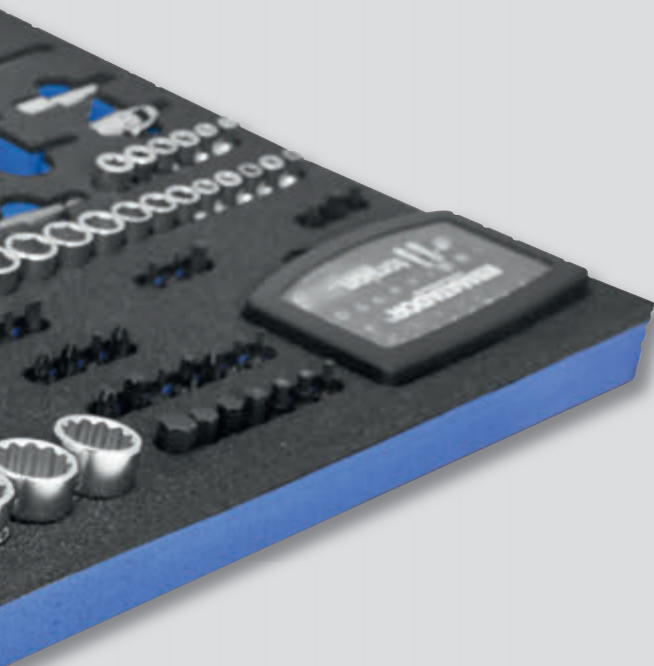

All inclusive.

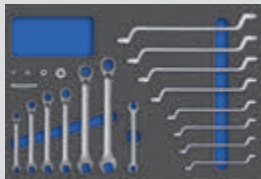
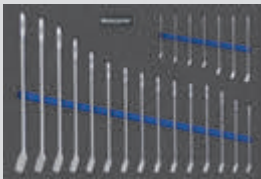

MTS unlimited edition: 8 modules with 350 high quality tools.

Additional modules for automotive repair.

Which tools do you need?

It depends... Your tasks change.

Do you really want to spend your time looking for the right tools for your latest challenge? Do your new tools fit into the tool modules and tool storage system you already use? Probably not.

When you check the market you will find almost uncountable offers of fully equipped tool trolleys - but **what do you really need?**

Save your time and keep an overview because we have a better idea:

We set up a **comprehensive database** including all equipped tool trolleys that we have ever supplied to **BMW, Ford, Jaguar Land Rover, Mercedes-Benz, Volkswagen** and other customers, and we broke them down to the single tool.

Additionally, we included important **OEM specifications - like Volkswagen VAS 275 001** - and took the tool trolley range of other tool manufacturers into consideration. The unsurprising result:

Around **88%** of the tools listed can be found in any specification because these tools are needed in every workshop.

We added another **10%** of tools that make sense and give you enough scope

for future tasks. So you do not need to look for further additions again.

What came out is our **"MTS unlimited edition" with 350 tools that cover 98% of all application fields.** It's a safe bet.

For the remaining 2% we saved you lots of time.

Make something out of it!

For automotive repairs we added two modules with a comprehensive 10 (3/8) socket set and another module for car body work.

You won't need more tools. For details please refer to:



MTS
unlimited edition

8



Ratchet Spanners with patented GearWrench®-technique - the original.



High-quality ratchets, 90 teeth, e.g. 12.5 (1/2) with torque up to 750 Nm.



Sockets in 5 star industrial quality with SUPER CHROM surface.



Innovative plier set with 3KsoftGRIP handles and many special features.



High-quality screwdriver set with ergonomic 2C handles.



Torsion-Bitbox, suitable for power and impact tools.

MTS unlimited edition.
350 high quality tools. 8 modules. That's it.
You won't need more tools.

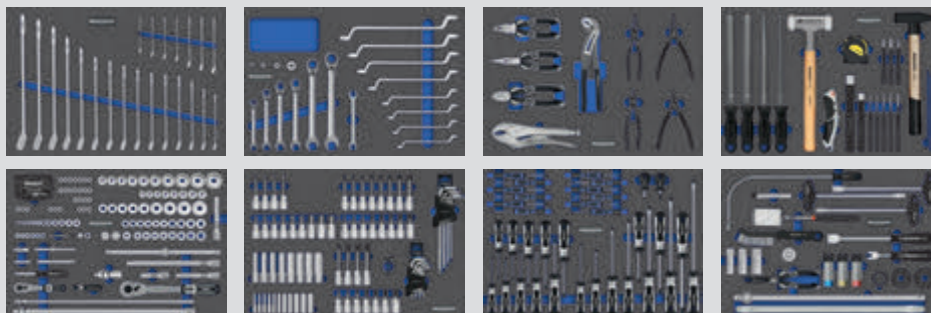

Tool assortment MTS unlimited edition (350 tools) without tool trolley

ART. CODE 8178 9350

1,899.- €



Tool assortment MTS unlimited edition + Tool Trolley RATIO (8 drawers)

ART. CODE 8163 9350

2,395.- €

■ **Combination Spanner Set**
DIN 3113 A, 22 pcs

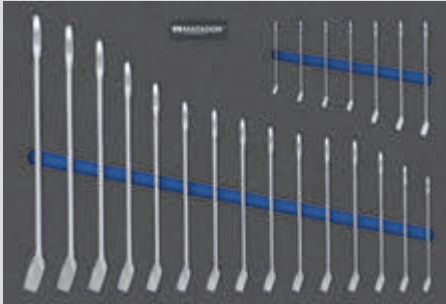

0185 6 - 22, 24, 27, 30, 32, 34 mm

ART. CODE **8164 3185** **22** **149.- €**

■ **Combination Ratchet Spanner and Double Ended Ring Spanner Set, 19 pcs**



0189 8, 10, 12, 13, 17, 19 mm + Adapters
0200 6 x 7 - 20 x 22 mm
0250 Flare nut ring spanners (open) 10 x 11 mm

ART. CODE **8164 3189** **19** **199.- €**

■ **Mechanic's Tool Set, 19 pcs**



Engineer's hammer 400 g, non-rebound mallet Ø40 mm, set of parallel pin punches, set of files, cutting knife (alu), measuring tape 5 m, etc.

ART. CODE **8164 1710** **19** **219.- €**

■ **Socket Set, 145 pcs** **1/4 1/2**

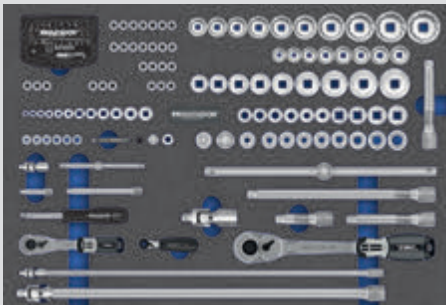

Torsion-Bitbox, Mini Bit Ratchet, Sockets in 6-pt. and double 6-pt., e.g. 4-34 mm, T6-T40, E4-E24, Set of Adapters, etc.

6.3 1/4 1.25 1/2 10 15 20 25 30 35 40 45 50 55 60 65 70 75 80 85 90 95 100 105 110 115 120 125 130 135 140 145 torsion

ART. CODE **8164 1214** **145** **399.- €**

■ **Screwdriver Sockets / Hex Key Set, 78 pcs** **1/4 1/2**

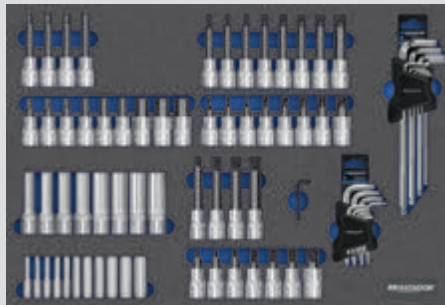

Sockets, long type SW 4-19 mm, screwdriver bit sockets in Hex 5-19, XZN M5-M16, T25-T60, L-Key wrenches 1.5-10 mm / T9-T50

ISO Grip 10 15 20 25 30 35 40 45 50 55 60 65 70 75 80 85 90 95 100 105 110 115 120 125 130 135 140 145

ART. CODE **8164 1492** **78** **349.- €**

■ **Automotive Tool Set, 24 pcs**



Magnetic pick up tools 1,000 g, T-handle socket wrench 8-13 mm, scraper, spark plug sockets and pliers, impact sockets 32-34 mm, tyre levers, etc.

ART. CODE **8164 1800** **24** **279.- €**

■ **Plier Set, 9 pcs**



Combination pliers, long round nose pliers, side cutters, water pump pliers, circlip pliers A2 - A21 - J2 - J21, grip pliers 250 MM / 10"

ART. CODE **8164 1510** **9** **209.- €**

■ **Screwdriver Set, 34 pcs**



2c screwdrivers slotted 0.6x4 - 2.0x12, PH 00-3, T5-T30, voltage testers, stubby screwdriver, precision mechanics set

2K 10 15 20 25 30 35 40 45 50 55 60 65 70 75 80 85 90 95 100 105 110 115 120 125 130 135 140 145

ART. CODE **8164 1600** **34** **199.- €**

■ **Additional modules**



Socket Set 3/8"
Sockets SW 6-22 mm, Screwdriver Sockets Hex 4-10, XZN M5-M10, T15-T50, spark plug tools, etc.

ART. CODE **8164 1310** **69** **249.- €**

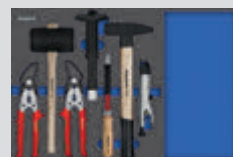

Set of bodywork tools
Rubber mallets, ideal lever tin snips (L/R), axial grip pliers, etc.

ART. CODE **8164 1745** **7** **299.- €**

■ Tool Assortment **UNIVERSAL**, 170 pcs

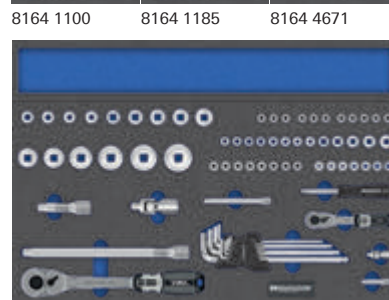

6.3 mm 1/4 12.5 mm 1/2

	0100	6 x 7 - 20 x 22 mm
	0185	6 - 8 - 10 - 11 - 13 14 - 17 - 19 - 22 mm
	0671	8 - 10 - 13 mm
	0442	1,5 - 10 mm
	2061	72
	2065	50, 100 mm
	2068	
	2073	150 mm
	2075	4 - 14 mm
	2076	4 - 5,5 - 7 mm
	2077	PH 1 - 2 - 3
	2078	3 - 4 - 5 - 6 - 8 mm
	2090	E4 - E8, E10, E11
	2092	T8 - T40
	4061	3/8"
	4065	75, 250 mm
	4068	
	4075	10 - 32 mm
	3K 0500	180 mm (7")
	3K 0530	180 mm (7")
	0556	240 mm (10")
	3K 0585	205 mm (8")
	0660	0,5 x 3 mm
	0615	0,8 x 5 - 1,0 x 5,5 1,2 x 6,5 mm
	0635	3 mm
	0655	PH 0 - PH 1 - PH 2
	0640	0,8 x 4 x 25 mm
	0641	PH 1
	0705	500 g
	0717	120 x 4 x 10 mm
	0718	3 - 4 - 5 - 6 mm
	0738	115 x 65 mm
	0762	Drillset HSS-R
	7052	Bitbox 31 pcs

The tool assortment **UNIVERSAL** is the basic assortment with the most important tools for general repair jobs. High quality tools for home users and DIYers in the tool world of MATADOR. The **7 modules** are available as a full tool assortment with or without the trolley **RATIO**. They contain:

- Combination spanners and double open ended spanners 6 - 22 mm
- Nut Drivers with T-handle 8 - 10 - 13 mm
- Socket set with 6.3 mm (1/4") and 12.5 mm (1/2") drive, sockets 4 - 32 mm
- Screwdriver sockets for slotted, PH, hex and TORX® screws E4 - E11, T8 - T40
- Plier set with **3KsoftGrip** handles
- Screwdriver set with 2-component handles for slotted and PH screws
- Mechanic's set with the most important striking tools
- 31-pc bitset and 25-pc drill assortment included

31-pc bitset with mini ratchet included.

25-pc twist drill assortment HSS-R included.



**All you need.
The expert's choice.**

Tool assortment **UNIVERSAL**

ART. CODE
8178 9550



499.- €



ART. CODE
8163 9550



Tool assortment **UNIVERSAL**
+ Tool Trolley **RATIO** (7 drawers)

895.- €

More information about our MTS module sets can be found at www.matador.de in our online catalog.



■ Tool Assortment **INDUSTRIAL**, 242 pcs

6.3 mm 1/4 12.5 mm 1/2

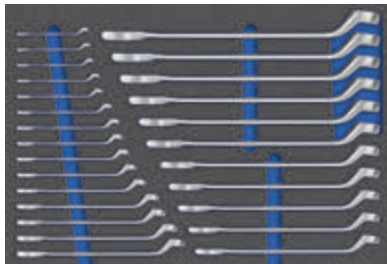

8164 3190

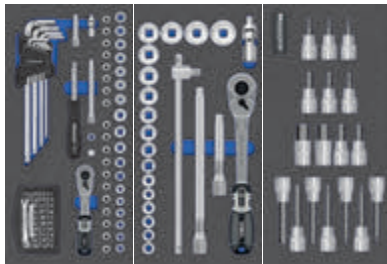

8164 1201

8164 1401

8164 4078

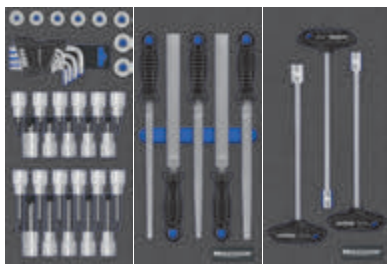

8164 4092

8164 1775

8164 4671

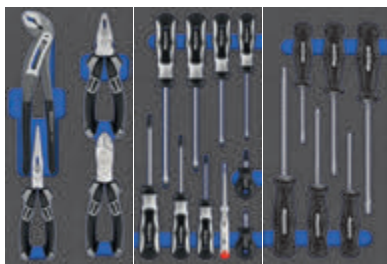

8164 1500

8164 1615

8164 1653



8164 1705

	0190	6 - 32 mm
	0442	1,5 - 10 mm
	2061	7/2
	2065	50, 100 mm
	2068	
	2073	150 mm
	2075	4 - 13 mm
	2076	4 - 5,5 - 7
	2077	PH 1 - 2 - 3
	2078	3 - 4 - 5 - 6 - 8
	2083	10 3/8
	2084	3/8 1/2
	2090	E4 - E8, E10, E11
	2092	T8 - T40
	7052	Bitbox 31 pcs
	4061	3/8
	4064	300 mm
	4065	125, 250 mm
	4068	
	4075	10 - 32 mm
	4078	4 - 19 x 62 mm 4 - 12 x 100 mm
	0443	T10 - T50
	4090	E10 - E24
	4092	T20 - T80 x 62 mm T20 - T80 x 100 mm
	0775	200 mm
	0671	8 - 10 - 13 mm
	0500	180 mm (7")
	0530	180 mm (7")
	0556	240 mm (10")
	0585	205 mm (8")
	0660	0,5 x 3 mm
	0615	0,8 x 5 - 1,0 x 5,5 1,2 x 6,5 mm
	0635	3 mm
	0655	PH 0 - PH 1 - PH 2
	0640	0,8 x 4 x 25 mm
	0641	PH 1
	0652	1,0 x 5,5 - 1,2 x 8 2,0 x 12 mm
	0655	PH 1 - PH 2 - PH 3
	0700	ø 22, 35 mm
	0702	ø 40 mm / 750 g
	0705	500, 1000 g
	0714	125 - 175 - 200 mm
	0715	125 - 175 - 200 mm
	0716	3 - 6, 8, 10 mm
	0717	120 x 4 x 10 mm
	0718	ø 2 - 6, 8, 10 mm



The tool assortment **INDUSTRIAL** was designed by experts especially for industrial maintenance and assembly jobs. All tools for the experienced mechanic are included. The **11 modules** are available as a full tool assortment with or without our tool trolley **RATIO**. They contain:

- Combination spanners, deep offset 6 - 32 mm
- Socket set with 6.3 mm (1/4") and 12.5 mm (1/2") drive, sockets 4 - 32 mm
- Comprehensive assortment of screwdriver sockets for slotted, PH, hex and TORX® screws E4 - E11, T8 - T40
- Plier set with **3KsoftGrip** handles
- Screwdriver set with 2-component handles for slotted, PH and TORX® screws and additional screwdriver set with striking cap
- Large mechanic's set with numerous striking tools
- and many more

Tool assortment **INDUSTRIAL**

ART. CODE
8178 9570



1,199.- €



Tool assortment **INDUSTRIAL**
+ Tool Trolley **RATIO** (7 drawers)

ART. CODE
8163 9570



1,695.- €

■ Tool assortment **AUTOMOTIVE**, 182 pcs

6.3 mm 1/4 12.5 mm 1/2

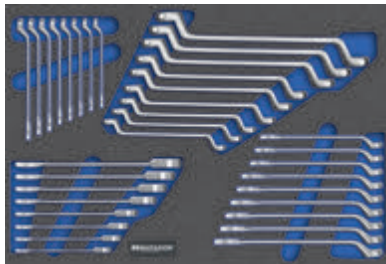

8164 1195

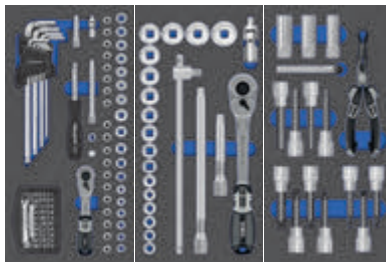

8164 1201 8164 1401 8164 1481



8164 1500 8164 1615 8164 1701



Tool assortment **AUTOMOTIVE**

ART. CODE **8188 9560** **799,- €**

Tool assortment **AUTOMOTIVE**
+ Tool Trolley **RATIO** (7 drawers)

ART. CODE **8163 9560** **1,295,- €**

- 0183 8 - 10 - 11 - 13
16 - 17 - 18 - 19 mm
- 0190 6 - 22 mm
- 0200 6 x 7 - 21 x 23 mm
- 0442 1,5 - 10 mm
- 2061 50, 100 mm
- 2065 50, 100 mm
- 2068 150 mm
- 2073 4 - 13 mm
- 2075 4 - 5,5 - 7
- 2076 PH 1 - 2 - 3
- 2077 3 - 4 - 5 - 6 - 8
- 2078 E4 - E8, E10, E11
- 2083 T8 - T40
- 2084 Bitbox 31 pcs
- 2090 13 x 0,05 - 1,00 mm
- 2092 16 - 18 - 20,8 mm
- 2092 M6 - M8 - M10
M12 x 100 mm
- 7052 T45 - T55
T70 x 100 mm
- 4061 180 mm (7")
- 4064 180 mm (7")
- 4065 240 mm (10")
- 4068 205 mm (8")
- 4075 0,5 x 3 mm
- 4076 0,8 x 5 - 1,0 x 5,5
1,2 x 6,5 mm
- 4077 3 mm
- 4078 PH 0 - PH 1 - PH 2
- 4079 0,8 x 4 x 25 mm
- 4081 PH 1
- 4082 500 g
- 4083 150 mm, 200 mm
- 4084 120 x 4 x 10 mm
- 4085 3 - 4 - 5 - 6 mm
- 4086 3 m
- 4087 18 mm
- 4088 100%
GREEN 37%
S1 S2 S3 S4



■ Tool assortment **TRUCK**, 201 pcs



AUTOMOTIVE + add-on module **TRUCK**



8164 1708

- 0100 24 x 27 - 25 x 28
30 x 32 mm
- 0185 24 - 27 - 30 -
32 mm
- 0200 24 x 27 - 25 x 28
30 x 32 mm
- 0600 1,2 x 8 x 150
1,6 x 10 x 175
2,0 x 12 x 200 mm
- 0650 PH 2 - PH 3 - PH 4
- 0702 øø 40 mm / 750 g
- 0705 1000 g
- 0754 500 mm

The tool assortment **TRUCK** contains the tool assortment **AUTOMOTIVE** and additionally a **19-pc module with basic tools for the repair of commercial vehicles**, e.g. spanners up to 32 mm and classical wooden screwdrivers with striking cap. The **8 modules** are available as a full tool assortment with or without our tool trolley **RATIO**.

Tool assortment **TRUCK**

ART. CODE **8178 9561** **999,- €**

Tool assortment **TRUCK**
+ Tool Trolley **RATIO** (7 drawers)

ART. CODE **8163 9561** **1,495,- €**

More information about our MTS module sets can be found at www.matador.de in our online catalog.



Selected tool assortments for automotive repair.

■ Tool Assortment INDUSTRIAL, 242 pcs

6.3 mm 1/4 10 mm 3/8 12.5 mm 1/2

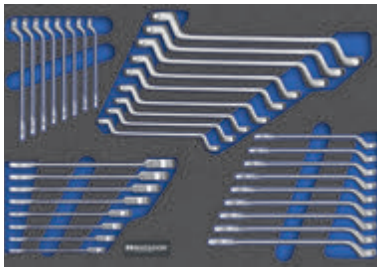

8164 1195

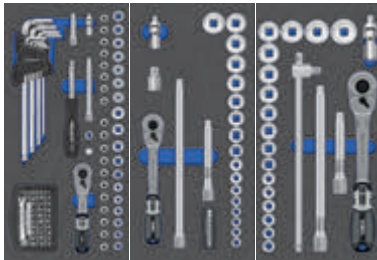

8164 1201 8164 1301 8164 1401

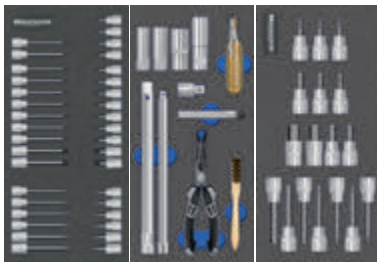

8164 3078 8164 3081 8164 4078

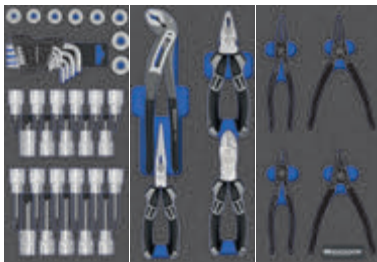

8164 4092 8164 1500 8164 1504



8164 1615 8164 1620 8164 1707

	0183	9 - 10 - 11 - 13 16 - 17 - 18 - 19 mm
	0190	6 - 22 mm
	0200	6 x 7 - 21 x 23 mm
	0442	1,5 - 10 mm
	2061	7/2"
	2065	50, 100 mm
	2068	
	2073	150 mm
	2075	4 - 13 mm
	2076	4 - 5,5 - 7
	2077	PH 1 - 2 - 3
	2078	3 - 4 - 5 - 6 - 8
	2083	10 3/8
	2084	6.3 1/4
	2090	E4 - E8, E10, E11
	2092	T8 - T40
	7052	Bitbox 31 pcs
	3061	3/8
	3065	125, 250 mm
	3068	
	3075	6 - 22 mm
	3083	12.5 1/2
	4061	3/8
	4064	300 mm
	4065	125, 250 mm
	4068	
	4075	10 - 32 mm
	3078	4 - 8, 10 x 48 mm 4 - 8, 10 x 92 mm
	3079	M5 - M6 - M8 - M10 x 48, M8 - M10 x 92 mm
	3092	T15 - 55 x 48 mm T15 - 55 x 92 mm
	0372	5/8 x 16 x 270 mm
	0383	14 x 250 mm
	0568	205 mm
	0633	6 - 24 V
	0760	13 x 0,05 - 1,00
	0781	
	3081	14 - 16 - 18 - 20,8
	4082	10 3/8
	4078	4 - 19 x 62 mm 4 - 12 x 100 mm
	0443	T10 - T50
	4090	E10 - E24
	4092	T20 - T80 x 62 mm T20 - T80 x 100 mm
	0500	180 mm (7")
	0530	180 mm (7")
	0556	240 mm (10")
	0585	205 mm (8")
		A2, A21, J2, J21
	0660	0,5 x 3 mm
	0615	0,8 x 5 - 1,0 x 5,5 1,2 x 6,5 mm
	0635	3 mm
	0655	PH 0 - PH 1 - PH 2
	0640	0,8 x 4 x 25 mm/PH1
	0620	T10 - T40
	0705	500 g
	0717	120 x 4 x 10 mm
	0718	3 - 4 - 5 - 6 mm
	0738	115 x 65 mm



The tool assortment **AUTOMOTIVE PRO** is a **comprehensive selection of tools for your workshop** (as recommended by **Ford** and **Jaguar Land Rover**) and has been compiled by many experts. The **13 modules** are available as a full tool assortment with or without our tool trolley **RATIO**. They contain:

- Socket set with 6.3 mm (1/4"), 10 mm (3/8") and 12.5 mm (1/2") drive, all sockets from 4 - 32 mm
- Comprehensive assortment of screwdriver sockets for slotted, PH, hex and TORX® screws E4 - E24, T8 - T55
- Tool set for spark plugs
- Plier set with **3KsoftGrip** handles
- Circlip plier set
- Comprehensive screwdriver set with 2-component handles for slotted, PH and TORX® screws
- Mechanic's set with the most important striking tools
- etc.

Tool assortment **AUTOMOTIVE PRO**

ART. CODE **8178 9580** **1,299.- €**

Tool assortment **AUTOMOTIVE PRO**
+ Tool Trolley **RATIO** (7 drawers)

ART. CODE **8163 9580** **1,795.- €**

Single modules.

Flexibly combine suitable MTS modules with workshop trolleys.

MATADOR was one of the first manufacturers to develop **two-colored soft foam inlays** for better tool organization in tool trolleys or drawers.

Today the **MATADOR Tool System MTS** includes **more than 100 different modules** and offers pre-configured and well-thought-out solutions for any application. The end user can choose from 2 different sizes that fit in a raster.

"Q" modules have a compact size of **340 x 190 mm (1/3)** or **340 x 440 mm (3/3)** and fit into most smaller standard tool trolleys. Available as 1/3 or 3/3 inlays the "Q" modules provide a basic tool equipment. Together with distance modules they also fit in all MATADOR trolleys.

"R" modules are the more **professional line**. They fit exactly into the MATADOR tool trolleys **RATIO, VARIO** and of course into the drawers of the **Men's Kitchen**[®]. The standard module size of **390 x 190 mm** allows many tools to be accommodated and therefore a comprehensive range is offered. The 3/3 modules sized 570 x 390 mm fill a complete drawer with tools. Empty modules help to easily combine different modules – for nearly unlimited applications.

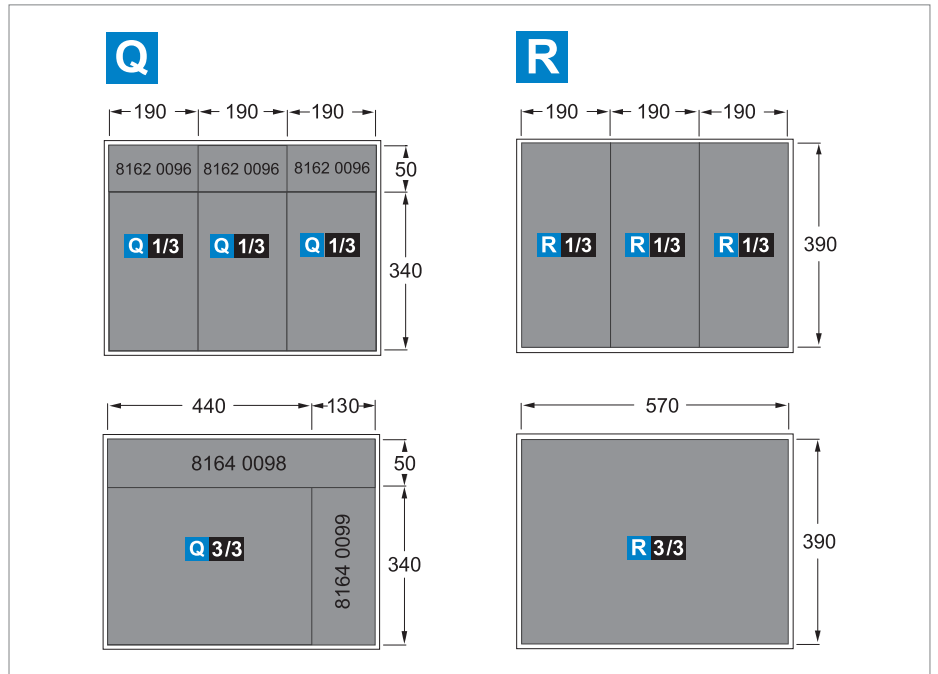

Set of Double Open Ended Spanners, DIN 3110, 12 pcs

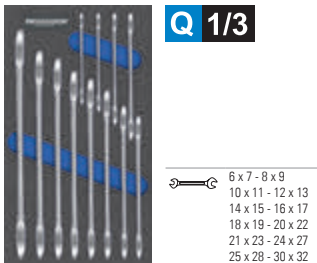

Q 1/3

- 6 x 7 - 8 x 9
- 10 x 11 - 12 x 13
- 14 x 15 - 16 x 17
- 18 x 19 - 20 x 22
- 21 x 23 - 24 x 27
- 25 x 28 - 30 x 32

ART. CODE **12** **8162 1100** **69.95 €**

Set of Combination Ratchet Spanners with Adapters, 12 pcs

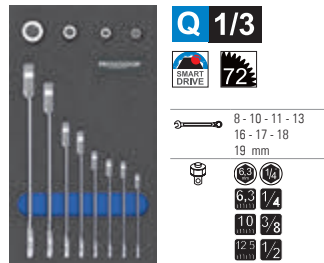

Q 1/3

- SMART DRIVE 72°
- 8 - 10 - 11 - 13
- 16 - 17 - 18
- 19 mm
- 6.3 1/4
- 10 3/8
- 12.5 1/2

ART. CODE **12** **8162 1183** **79.95 €**

Set of Combination Spanners DIN 3113 A, 12 pcs

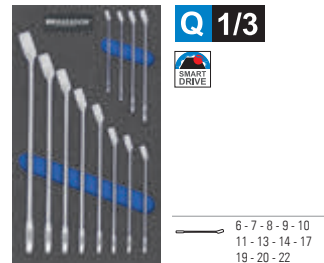

Q 1/3

- 6 - 7 - 8 - 9 - 10
- 11 - 13 - 14 - 17
- 19 - 20 - 22

ART. CODE **12** **8162 1185** **69.95 €**

Screwdriver Sockets Hex, 16 pcs

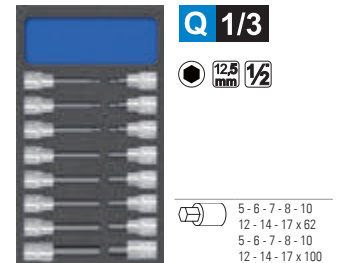

Q 1/3

- 12.5 mm 1/2
- 5 - 6 - 7 - 8 - 10
- 12 - 14 - 17 x 62
- 5 - 6 - 7 - 8 - 10
- 12 - 14 - 17 x 100

ART. CODE **16** **8162 1478** **89.95 €**

Screwdriver Sockets, XZN/RIBE[®], 20 pcs

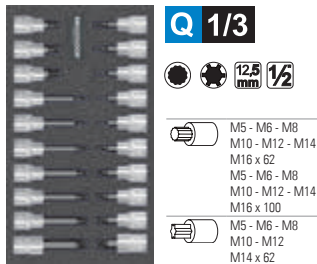

Q 1/3

- 12.5 mm 1/2
- M5 - M6 - M8
- M10 - M12 - M14
- M16 x 62
- M5 - M6 - M8
- M10 - M12 - M14
- M16 x 100
- M5 - M6 - M8
- M10 - M12
- M14 x 62

ART. CODE **20** **8162 1479** **119.95 €**

Screwdriver Sockets, TORX[®], 24 pcs

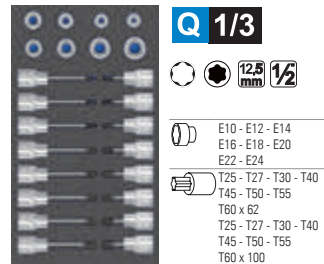

Q 1/3

- 12.5 mm 1/2
- E10 - E12 - E14
- E16 - E18 - E20
- E22 - E24
- T25 - T27 - T30 - T40
- T45 - T50 - T55
- T60 x 62
- T25 - T27 - T30 - T40
- T45 - T50 - T55
- T60 x 100

ART. CODE **24** **8162 1490** **99.95 €**

Plier Set 3 pcs



Q 1/3

- 3K
- 165 mm (6.1/2")
- 160 mm (6.1/4")
- 240 mm

ART. CODE **3** **8162 1500** **89.95 €**

Plier Set VDE 3 pcs

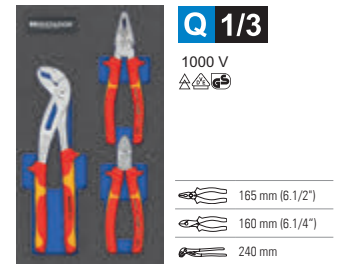

Q 1/3

- 1000 V
- 165 mm (6.1/2")
- 160 mm (6.1/4")
- 240 mm

ART. CODE **3** **8162 1501** **99.95 €**

**Screwdriver Set
8 pcs**

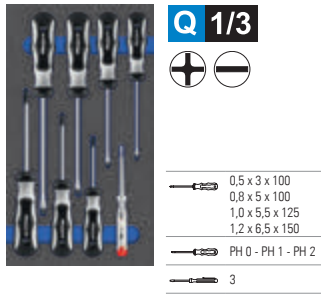

ART. CODE **8**
8162 1615 **39.95 €**

**Screwdriver Set VDE
8 pcs**

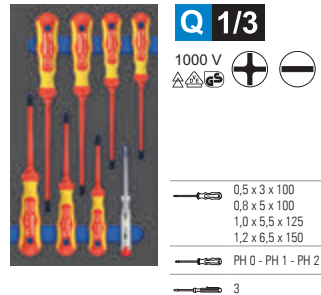

ART. CODE **8**
8162 1616 **49.95 €**

**Screwdriver Set
TORX®, 6 pcs**

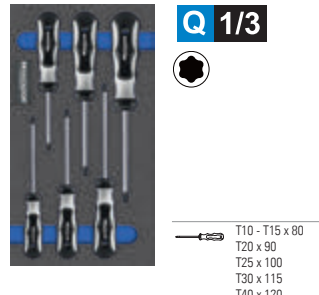

ART. CODE **6**
8162 1620 **39.95 €**

**Screwdriver Set
with Striking Cap, 6 pcs**

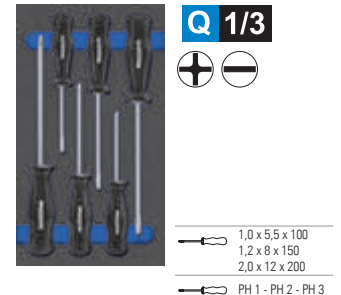

ART. CODE **6**
8162 1653 **34.95 €**

**Set of Double Ended Ring Spanners
DIN 838, 13 pcs**

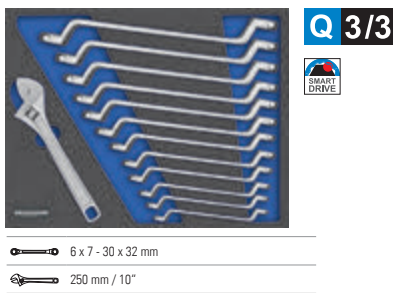

ART. CODE **13**
8162 1200 **99.95 €**

**Set of Spanners XL,
DIN 3113 A / DIN 3110, 26 pcs**

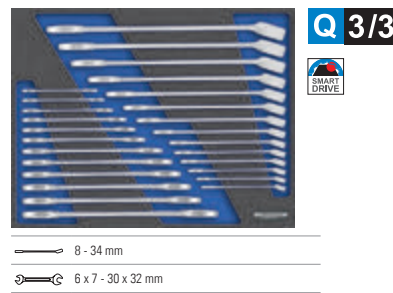

ART. CODE **26**
8162 2100 **159.95 €**

**Socket Set
66 pcs**

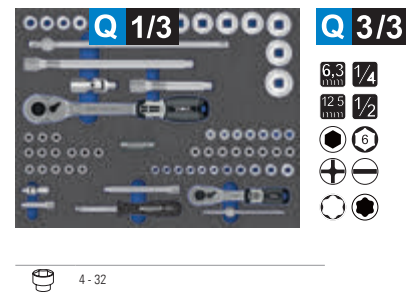

ART. CODE **66**
8162 6063 **199.95 €**

**Mechanic's Tools / Pliers
14 pcs**

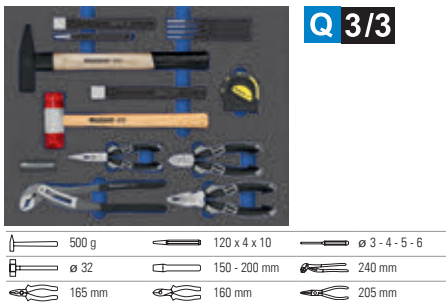

ART. CODE **14**
8162 1701 **179.95 €**

**Mechanic's Tools / Pliers VDE
14 pcs**

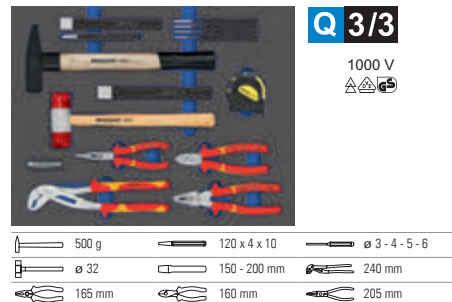

ART. CODE **14**
8162 1702 **199.95 €**

**Mechanic's Tools XL
18 pcs**

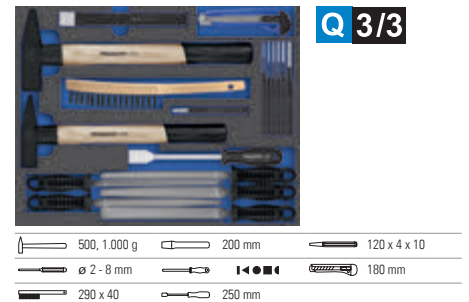

ART. CODE **18**
8162 1703 **149.95 €**

Empty Module



ART. CODE
8162 0095 **17.95 €**

Distance Modules

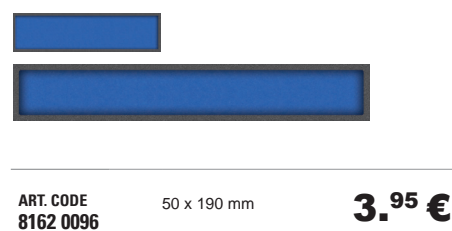

Q modules.
The compact size.

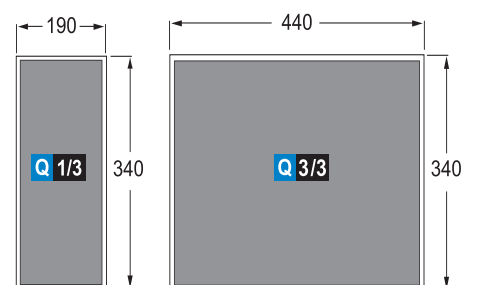

R modules.

Perfectly organized. See what's missing.

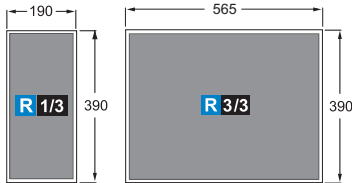

MTS MATADOR TOOL SYSTEM.

■ Set of Double Open Ended Spanners XL, DIN 3110, 8 pcs

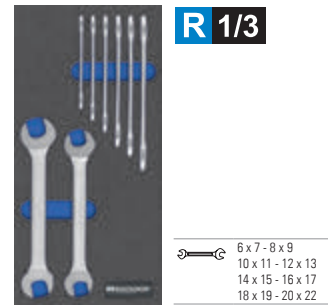

ART. CODE **8** 8164 1100 **49.95 €**

■ Set of Double Open Ended Spanners XL, DIN 3110, 13 pcs

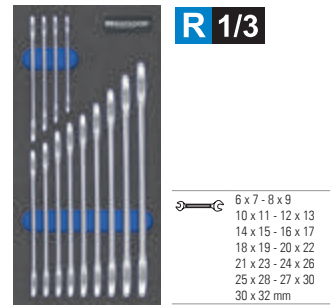

ART. CODE **13** 8164 3100 **79.95 €**

■ Set of Combination Ratchet Spanners with Adapters, 14 pcs

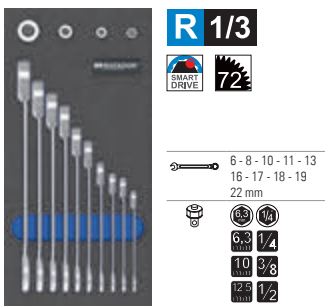

ART. CODE **14** 8164 1183 **119.95 €**

■ Set of Combination Spanners DIN 3113 A, 9 pcs

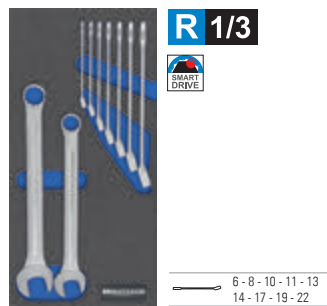

ART. CODE **9** 8164 1185 **49.95 €**

■ Set of Combination Spanners DIN 3113 B, 9 pcs

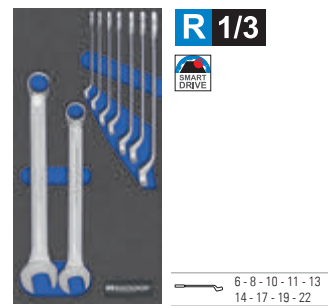

ART. CODE **9** 8164 1190 **59.95 €**

■ Set of Pipe Head Spanners 12 pcs

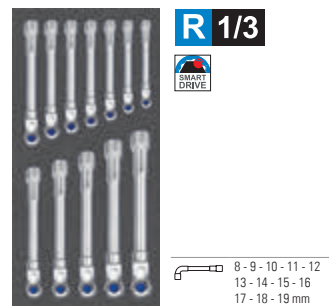

ART. CODE **12** 8164 1320 **99.95 €**

■ Set of Combination Ratchet Spanners XL, 23 pcs

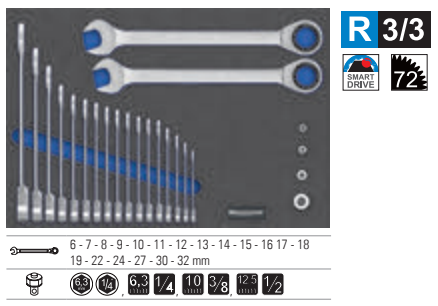

ART. CODE **23** 8164 2183 **299.95 €**

■ Set of Combination Spanners XL DIN 3113 A, 22 pcs

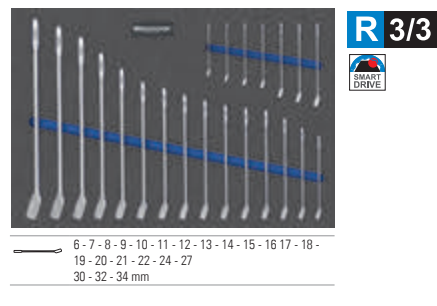

ART. CODE **22** 8164 3185 **149.95 €**

■ Set of Combination Spanners XL DIN 3113 B, 26 pcs

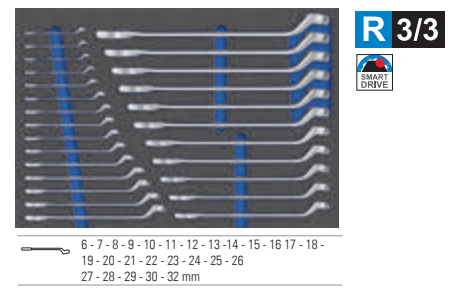

ART. CODE **26** 8164 3190 **199.95 €**

■ Set of Double Ended Ring Spanners DIN 838, 12 pcs

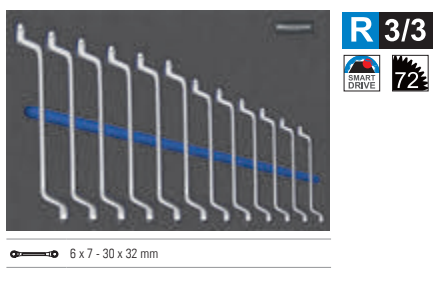

ART. CODE **12** 8164 1200 **109.95 €**

■ Set of Spanners and Combination Ratchet Spanners, 34 pcs

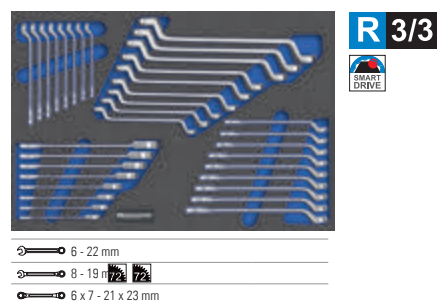

ART. CODE **34** 8164 1195 **249.95 €**

■ Supplementary Spanners Set 15 pcs

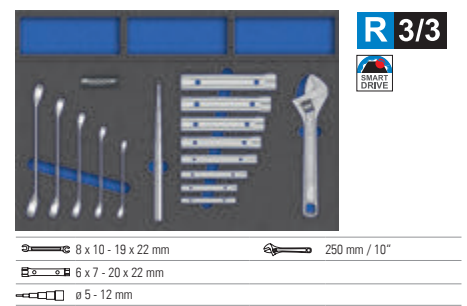

ART. CODE **15** 8164 1251 **129.95 €**

■ Set of Nut Drivers with T-Handle, 3 pcs



R 1/3

6 - 7 - 8 x 230

ART. CODE **3** 8164 1671 **32.95 €**

■ Set of Nut Drivers with T-Handle, 3 pcs



R 1/3

9 - 10 - 11 x 230

ART. CODE **3** 8164 2671 **34.95 €**

■ Set of Nut Drivers with T-Handle, 3 pcs



R 1/3

12 - 13 - 14 x 230

ART. CODE **3** 8164 3671 **36.95 €**

■ Set of Nut Drivers with T-Handle, 3 pcs



R 1/3

8 - 10 - 13 x 230

ART. CODE **3** 8164 4671 **38.95 €**

■ Socket Set 85 pcs

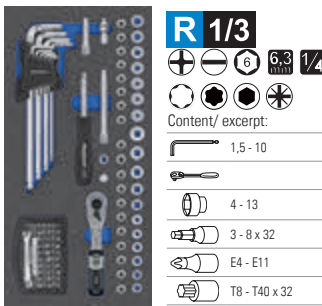

R 1/3

6 6.3 10 1/4

Content/ excerpt:

- 1.5 - 10
- 4 - 13
- 3 - 8 x 32
- E4 - E11
- T8 - T40 x 32

ART. CODE **85** 8164 1201 **149.95 €**

■ Socket Set 22 pcs

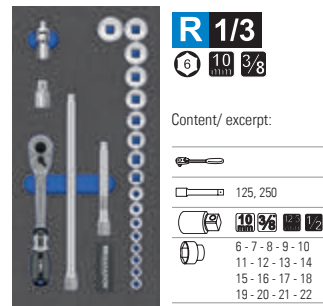

R 1/3

6 10 3/8

Content/ excerpt:

- 125, 250
- 10 3/8 1/2
- 6 - 7 - 8 - 9 - 10
- 11 - 12 - 13 - 14
- 15 - 16 - 17 - 18
- 19 - 20 - 21 - 22

ART. CODE **22** 8164 1301 **99.95 €**

■ Screwdriver Sockets Hex, TORX®, XZN, 36 pcs

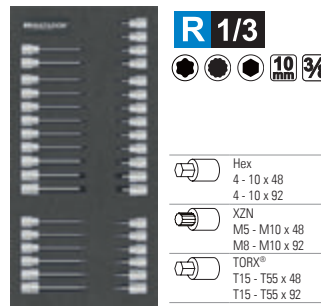

R 1/3

10 3/8

- Hex 4 - 10 x 48, 4 - 10 x 92
- XZN M5 - M10 x 48, M8 - M10 x 92
- TORX® T15 - T55 x 48, T15 - T55 x 92

ART. CODE **36** 8164 3078 **129.95 €**

■ Tool Set for Spark Plugs 11 pcs

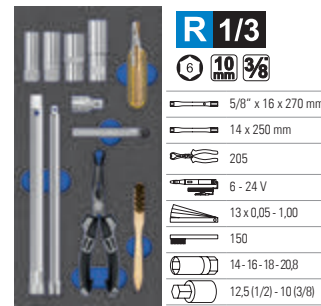

R 1/3

6 10 3/8

- 5/8" x 16 x 270 mm
- 14 x 250 mm
- 205
- 6 - 24 V
- 13 x 0.05 - 1.00
- 150
- 14 - 16 - 18 - 20.8
- 12.5 (1/2) - 10 (3/8)

ART. CODE **11** 8164 3081 **119.95 €**

■ Socket Set (long type), 32 pcs

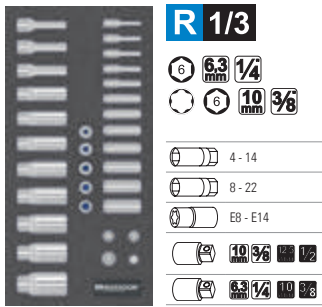

R 1/3

6 6.3 10 1/4

- 4 - 14
- 8 - 22
- E8 - E14
- 10 3/8 1/2
- 6.3 1/4 10 3/8

ART. CODE **32** 8164 3082 **129.95 €**

■ Screwdriver Sockets 28 pcs

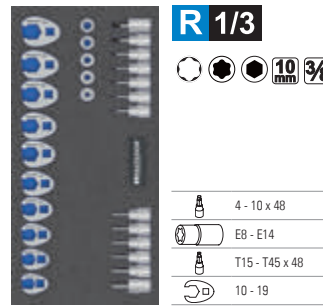

R 1/3

10 3/8

- 4 - 10 x 48
- E8 - E14
- T15 - T45 x 48
- 10 - 19

ART. CODE **28** 8164 3093 **109.95 €**

■ Socket Set 22 pcs

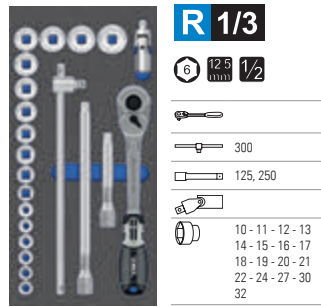

R 1/3

6 12.5 1/2

- 300
- 125, 250
- 10 - 11 - 12 - 13
- 14 - 15 - 16 - 17
- 18 - 19 - 20 - 21
- 22 - 24 - 27 - 30
- 32

ART. CODE **22** 8164 1401 **119.95 €**

■ Socket Set (long type) 14 pcs

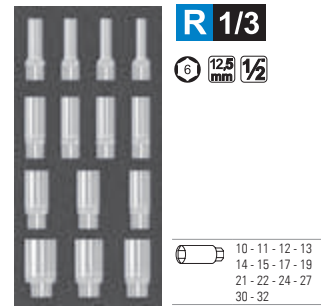

R 1/3

6 12.5 1/2

- 10 - 11 - 12 - 13
- 14 - 15 - 17 - 19
- 21 - 22 - 24 - 27
- 30 - 32

ART. CODE **14** 8164 4081 **99.95 €**

■ Supplementary Set 16 pcs

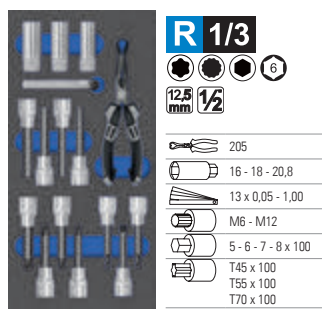

R 1/3

12.5 1/2

- 205
- 16 - 18 - 20.8
- 13 x 0.05 - 1.00
- M6 - M12
- 5 - 6 - 7 - 8 x 100
- T45 x 100
- T55 x 100
- T70 x 100

ART. CODE **16** 8164 1481 **139.95 €**

■ Screwdriver Sockets 17 pcs

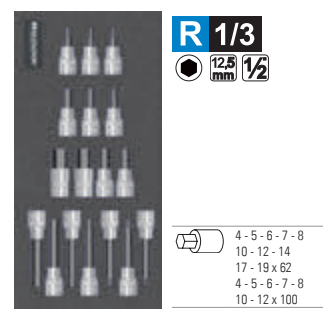

R 1/3

12.5 1/2

- 4 - 5 - 6 - 7 - 8
- 10 - 12 - 14
- 17 - 19 x 62
- 4 - 5 - 6 - 7 - 8
- 10 - 12 x 100

ART. CODE **17** 8164 4078 **99.95 €**

■ Screwdriver Sockets, XZN/RIBE®, 21 pcs

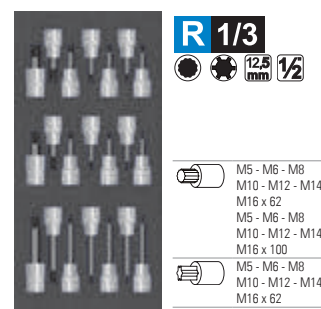

R 1/3

12.5 1/2

- M5 - M6 - M8
- M10 - M12 - M14
- M16 x 62
- M5 - M6 - M8
- M10 - M12 - M14
- M16 x 100
- M5 - M6 - M8
- M10 - M12 - M14
- M16 x 62

ART. CODE **21** 8164 4079 **139.95 €**

■ Screwdriver Sockets, TORX®, 39 pcs

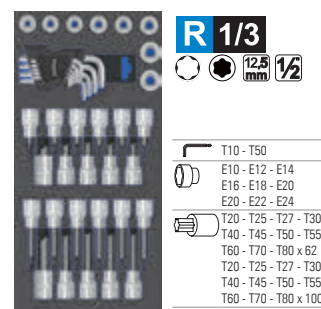

R 1/3

12.5 1/2

- T10 - T50
- E10 - E12 - E14
- E16 - E18 - E20
- E20 - E22 - E24
- T20 - T25 - T27 - T30
- T40 - T45 - T50 - T55
- T60 - T70 - T80 x 62
- T20 - T25 - T27 - T30
- T40 - T45 - T50 - T55
- T60 - T70 - T80 x 100

ART. CODE **39** 8164 4092 **169.95 €**

Impact Sockets (short type)
24 pcs

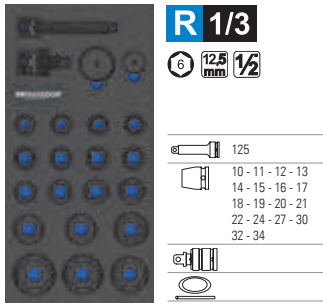

R 1/3
6 12.5 mm 1/2

- 125
- 10 - 11 - 12 - 13
- 14 - 15 - 16 - 17
- 18 - 19 - 20 - 21
- 22 - 24 - 27 - 30
- 32 - 34

ART. CODE **24**
8164 7475 **99.95 €**

Impact Sockets (long type)
19 pcs

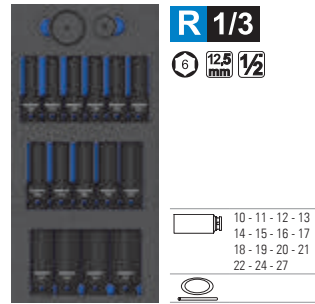

R 1/3
6 12.5 mm 1/2

- 10 - 11 - 12 - 13
- 14 - 15 - 16 - 17
- 18 - 19 - 20 - 21
- 22 - 24 - 27

ART. CODE **19**
8164 7481 **99.95 €**

Impact Sockets
14 pcs

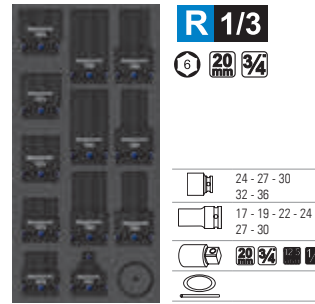

R 1/3
6 20 mm 3/4

- 24 - 27 - 30
- 32 - 36
- 17 - 19 - 22 - 24
- 27 - 30

ART. CODE **14**
8164 7575 **149.95 €**

Pneumatic Tool Set
2 pcs



R 1/3
12.5 mm 1/2

- 1.490 N·m

ART. CODE **2**
8164 1700 **249.95 €**

Set of Nut Drivers with T-Handle
15 pcs

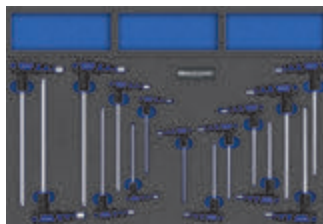

R 3/3
6

- 2 - 3 - 4 - 5 - 6 - 8 - 10
- T10 - T15 - T20 - T25 - T27 - T30 - T40 - T45

ART. CODE **15**
8164 1441 **129.95 €**

Socket Set L
72 pcs



R 3/3
6.3 mm 1/4
12.5 mm 1/2
6

- 1,5 - 10
- 4 - 32

ART. CODE **72**
8164 1411 **279.95 €**

Socket Set XL
120 pcs

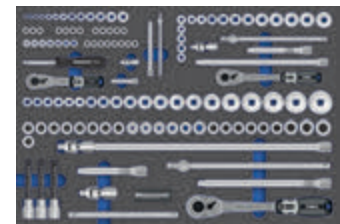

R 3/3
6.3 mm 1/4
10 mm 3/8
12.5 mm 1/2
6

- E4 - E24
- 4 - 32
- T8 - T70

ART. CODE **120**
8164 1421 **499.95 €**

Plier Set
4 pcs

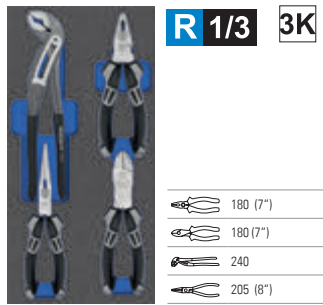

R 1/3
3K

- 180 (7")
- 180 (7")
- 240
- 205 (8")

ART. CODE **4**
8164 1500 **109.95 €**

Plier Set
4 pcs

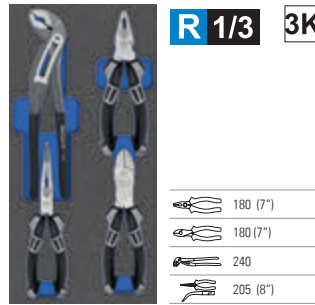

R 1/3
3K

- 180 (7")
- 180 (7")
- 240
- 205 (8")

ART. CODE **4**
8164 1501 **109.95 €**

Circlip Plier Set
4 pcs

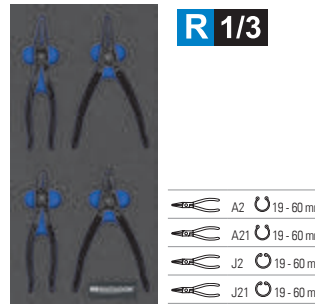

R 1/3

- A2 U 19 - 60 mm
- A21 U 19 - 60 mm
- J2 O 19 - 60 mm
- J21 O 19 - 60 mm

ART. CODE **4**
8164 1504 **69.95 €**

Circlip Plier Set XL
4 pcs

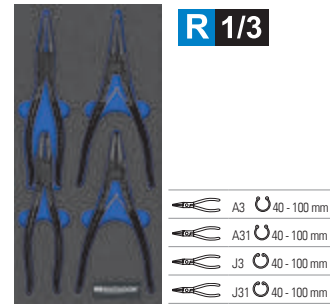

R 1/3

- A3 U 40 - 100 mm
- A31 U 40 - 100 mm
- J3 O 40 - 100 mm
- J31 O 40 - 100 mm

ART. CODE **4**
8164 1505 **89.95 €**

Screwdriver Set
10 pcs

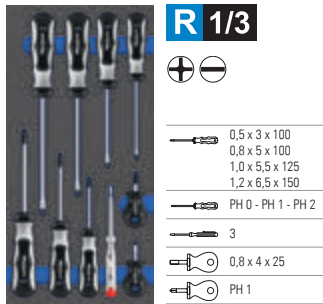

R 1/3
+

- 0,5 x 3 x 100
- 0,8 x 5 x 100
- 1,0 x 5,5 x 125
- 1,2 x 6,5 x 150
- PH 0 - PH 1 - PH 2
- 3
- 0,8 x 4 x 25
- PH 1

ART. CODE **10**
8164 1615 **49.95 €**

Screwdriver Set (TORX®), 6 pcs

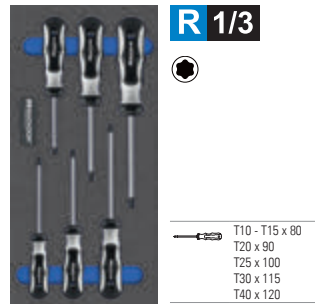

R 1/3
•

- T10 - T15 x 80
- T20 x 90
- T25 x 100
- T30 x 115
- T40 x 120

ART. CODE **6**
8164 1620 **49.95 €**

Screwdriver Set with Striking Cap, 6 pcs

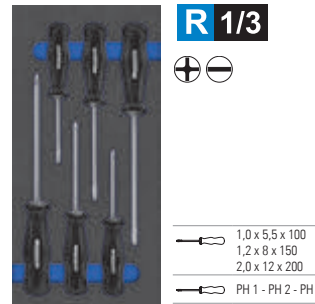

R 1/3
+

- 1,0 x 5,5 x 100
- 1,2 x 8 x 150
- 2,0 x 12 x 200
- PH 1 - PH 2 - PH 3

ART. CODE **6**
8164 1653 **49.95 €**

Precision Tool Set
17 pcs

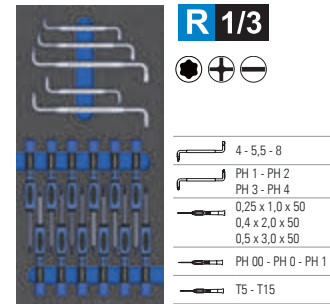

R 1/3
• + -

- 4 - 5,5 - 8
- PH 1 - PH 2
- PH 3 - PH 4
- 0,25 x 1,0 x 50
- 0,4 x 2,0 x 50
- 0,5 x 3,0 x 50
- PH 00 - PH 0 - PH 1
- T5 - T15

ART. CODE **17**
8164 1663 **49.95 €**

Plier Set VDE
4 pcs

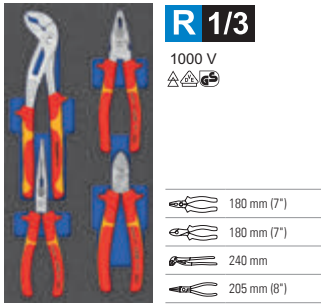

R 1/3

1000 V
⚡ ⚡ ⚡

- 180 mm (7")
- 180 mm (7")
- 240 mm
- 205 mm (8")

ART. CODE **4**
8164 1502 **129.95 €**

Plier Set VDE
4 pcs

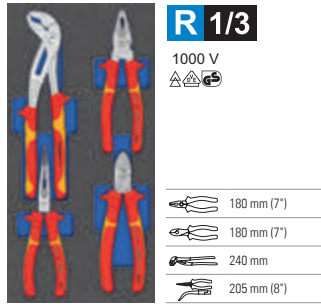

R 1/3

1000 V
⚡ ⚡ ⚡

- 180 mm (7")
- 180 mm (7")
- 240 mm
- 205 mm (8")

ART. CODE **4**
8164 1503 **129.95 €**

Screwdriver Set VDE
10 pcs

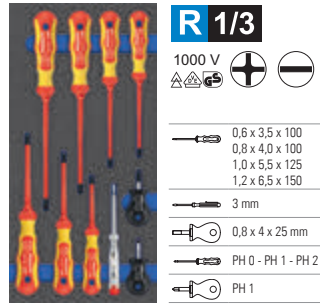

R 1/3

1000 V
⚡ ⚡ ⚡

- 0,6 x 3,5 x 100
- 0,8 x 4,0 x 100
- 1,0 x 5,5 x 125
- 1,2 x 6,5 x 150
- 3 mm
- 0,8 x 4 x 25 mm
- PH 0 - PH 1 - PH 2
- PH 1

ART. CODE **10**
8164 1616 **59.95 €**

File Set
5 pcs

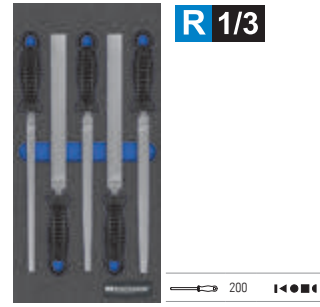

R 1/3

- 200

ART. CODE **5**
8164 1775 **49.95 €**

Mechanic's Tools Basic
11 pcs



R 1/3

Lumen 27
High End CREE
7h

- 500 g
- 150, 200 mm
- 120 x 4 x 10 mm
- ø 3 - 4 - 5 - 6 mm
- 3 m
- 180 mm
- 138 mm

ART. CODE **11**
8164 1701 **99.95 €**

Mechanic's Tools Supplement, 7 pcs

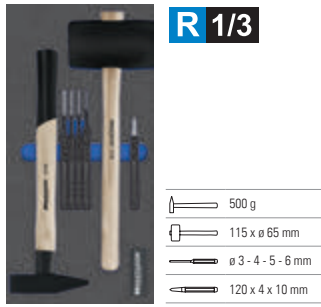

R 1/3

- 500 g
- 115 x ø 65 mm
- ø 3 - 4 - 5 - 6 mm
- 120 x 4 x 10 mm

ART. CODE **7**
8164 1707 **59.95 €**

Torque Tool Set 9 x 12
18 pcs

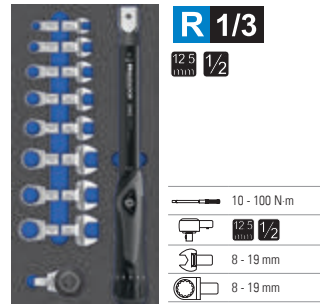

R 1/3

12,5 mm 1/2

- 10 - 100 N·m
- 8 - 19 mm
- 8 - 19 mm

ART. CODE **18**
8164 6176 **399.95 €**

Torque Tool Set 9 x 12
17 pcs

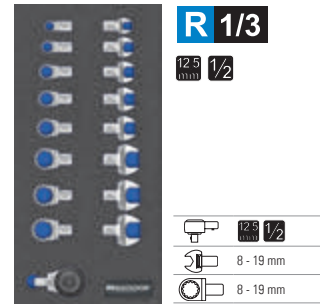

R 1/3

12,5 mm 1/2

- 8 - 19 mm
- 8 - 19 mm

ART. CODE **17**
8164 6190 **249.95 €**

Mechanic's Tools
25 pcs

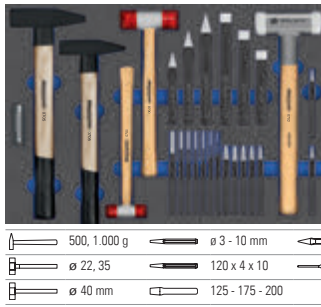

R 3/3

- 500, 1.000 g
- ø 3 - 10 mm
- 125 - 175 - 200
- ø 22, 35
- 120 x 4 x 10
- ø 2 - 10
- ø 40 mm
- 125 - 175 - 200

ART. CODE **25**
8164 1705 **249.95 €**

Mechanic's Tools
12 pcs

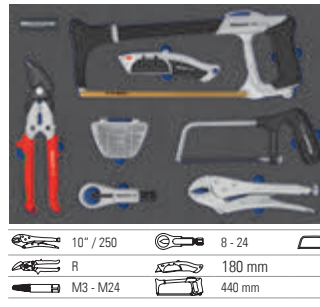

R 3/3

- 10" / 250
- 8 - 24
- 250 mm
- R
- 180 mm
- M3 - M24
- 440 mm

ART. CODE **12**
8164 1786 **229.95 €**

Measuring Instruments
11 pcs

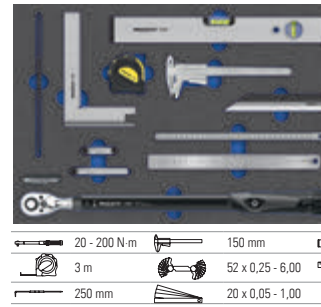

R 3/3

- 20 - 200 N·m
- 150 mm
- 400 mm
- 3 m
- 52 x 0,25 - 6,00
- 300 mm
- 250 mm
- 20 x 0,05 - 1,00
- 200 x 130 mm

ART. CODE **11**
8164 1798 **349.95 €**

Truck Set
19 pcs

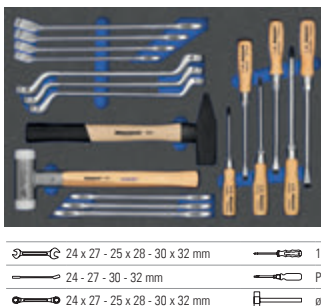

R 3/3

- 24 x 27 - 25 x 28 - 30 x 32 mm
- 1,2 - 1,6 - 2,0
- 24 - 27 - 30 - 32 mm
- PH 2 - PH 3 - PH 4
- 24 x 27 - 25 x 28 - 30 x 32 mm
- ø 40 mm / 750 g

ART. CODE **19**
8164 1708 **199.95 €**

Self Cutting Module

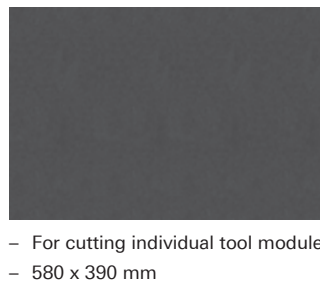

R 3/3

- For cutting individual tool modules
- 580 x 390 mm

ART. CODE
8164 9999 **29.95 €**

Empty Module



R 1/3

- 1/3 empty module for individual tools
- 195 x 390 mm

ART. CODE
8164 0095 **19.95 €**

Time to go new ways.

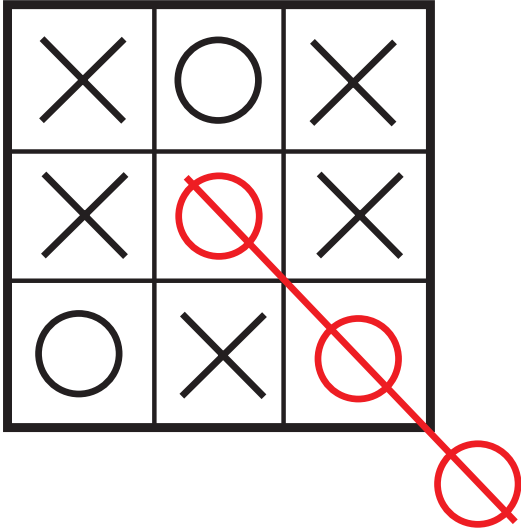

Cubes

by MATADOR.



MATADOR Cubes.

The most important tools in 5 Cube sizes. Freely combinable.



Small. Angular. Flexible. For everywhere.

Do you know the following problems?

- You own several cases for power tools, hand tools, small parts, etc. and whenever you prepare for work you pack half of your workshop and take it to the place of action.
- Chaos dominates your tool cases. You do not find anything.
- You just need only a couple of tools.
- You simply cannot find the specific tools you just need.
- Your tools are stored in another place and are not available at the moment.
- You do not like pre-configured blow-moulded tool cases because your favorite tools do not fit in or they contain tools you really don't need.

If these problems meet your profile, then you should change something. We can provide you with a solution: MATADOR Cubes.

MATADOR Cubes are **compact tools modules** in 5 sizes. They can be combined extremely flexible, they fit into any place and help to create a perfect order.

No more looking for tools. No more loss. Scratch-resistant. Shakeproof. Directly on site.

5 sizes. 1 basic raster. From 104 x 52 mm.

- For workbenches
- For tool trolleys
- For kitchen drawers
- For desk drawers
- For central trays in cars
- For Sortimo L-BOXX®
- For TANOS systainer®
- For raaco cases
- For W.AG cases
- For BAUHAUS system boxes
- For Stanley FatMax Organizer
- For rose plastic
- For Hofbauer
- For Würth plastic cases
- etc.

For workshop, home and hobby. For almost any drawer or box you want to put your tools in.

High quality tools with a system. Also perfect as supplementary equipment.

Do what you want.

Select what you need and where you need it.



Cubes 
by MATADOR.

Perfect for all places where you would like to have your tools.

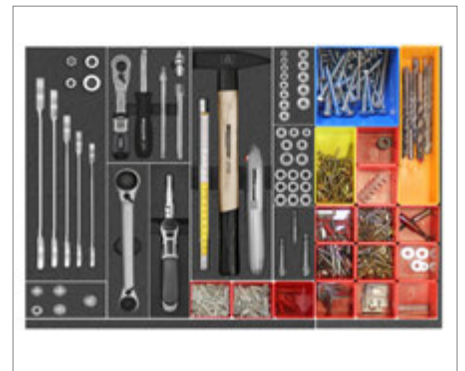
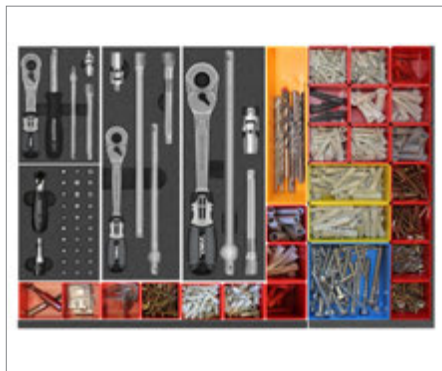
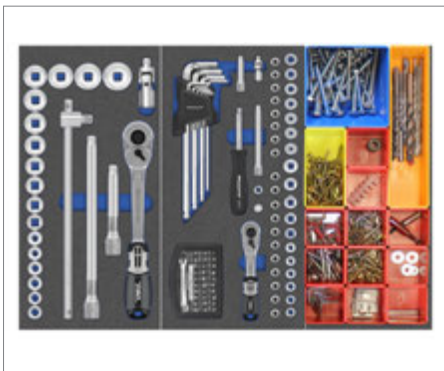

MATADOR Cubes.

The small sizes XS and S.

XS 104 mm
52 mm



Hex Power Shanks

3-pc. set of Hex Power Shanks: 6.3 (1/4) - 10 (3/8) - 12.5 (1/2)
Arranged in shakeproof soft foam inlay 104 (L) x 52 (W) x 60 (H).



ART. CODE **8150 3085** **19.95 €**

Socket Adaptors

5-pc. set of Socket Adaptors: 12.5 (1/2) - 10 (3/8); 10 (3/8) - 12.5 (1/2); 10 (3/8) - 6.3 (1/4); 6.3 (1/4) - 10 (3/8); 6.3 (1/4) - 6.3 (1/4) Bit.
Arranged in shakeproof soft foam inlay 104 (L) x 52 (W) x 60 (H).



ART. CODE **8150 2085** **14.95 €**

Sockets, short type

6.3 mm 1/4"

13-pc. set of sockets, **short type**, 6-point, with SmartDrive-Profile, 4-14 mm.
Arranged in shakeproof soft foam inlay 104 (L) x 52 (W) x 60 (H).



4 - 4.5 - 5 - 5.5 - 6 - 7 - 8 - 9 - 10 - 11 - 12 - 13
14 mm

ART. CODE **8150 2075** **19.95 €**

Sockets, long type

6.3 mm 1/4"

13-pc. set of sockets, **long type**, 6-point, with SmartDrive-Profile, 4-14 mm.
Arranged in shakeproof soft foam inlay 104 (L) x 52 (W) x 60 (H).



4 - 4.5 - 5 - 5.5 - 6 - 7 - 8 - 9 - 10 - 11 - 12 - 13
14 mm

ART. CODE **8150 2081** **34.95 €**

Screwdriver Sockets

6.3 mm 1/4"

15-pc. set of screwdriver sockets with bits made of special steel.
Arranged in shakeproof soft foam inlay 104 (L) x 52 (W) x 60 (H).



2076 4 - 5.5 - 7 mm
2077 PH 1 - PH 2 - PH 3
2077 PZ 1 - PZ 2 - PZ 3
2078 3 - 4 - 5 - 6 - 8 - 10

ART. CODE **8150 2076** **28.95 €**

Screwdriver Sockets

6.3 mm 1/4"

16-pc. set of sockets and screwdriver sockets TORX® with bits made of special steel.
Arranged in shakeproof soft foam inlay 104 (L) x 52 (W) x 60 (H).



2092 T6 - T8 - T10 - T15 - T20 - T25 - T27 - T30 - T40
2090 E4 - E5 - E6 - E7 - E8 - E10 - E11

ART. CODE **8150 2092** **25.95 €**



S 208 mm
52 mm

4in1 Ring Ratchet Spanner

72°

The most important sizes in one spanner: 10 - 13 - 17 - 19 mm.
Arranged in shakeproof soft foam inlay 208 (L) x 52 (B) x 60 (H).



ART. CODE **8150 0184** **29.95 €**

Pliers

High quality MATADOR pliers with several functions and **3KsoftGrip sleeve**.
Arranged in shakeproof soft foam inlay 208 (L) x 52 (B) x 60 (H).



0500 Combination Pliers, 180 mm (7")

ART. CODE **8150 0500** **25.95 €**



0530 Heavy Duty Side Cutter, 180 mm (7")

ART. CODE **8150 0530** **29.95 €**



0585 Flat Nose Pliers, 170 mm (6.3/4"), straight type

ART. CODE **8150 0585** **28.95 €**

MATADOR Cubes.

The medium sizes M and L.

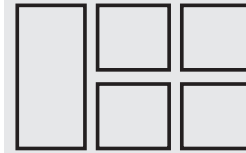

Template.

The Cube template helps you to select the suitable cubes for your individual working environment. Simply print it out.

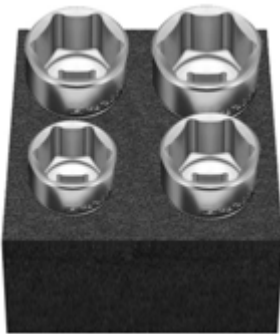

Sockets XL



4-pc. set of sockets, 6-point, with SmartDrive-Profile, 24-32 mm. Arranged in shakeproof soft foam inlay 104 (L) x 104 (W) x 60 (H).



12,5 mm 1/2 4075 24 - 27 - 30 - 32 mm

ART. CODE **8150 4175** **14.95 €**

Mechanic's Tools

6-pc. set of Striking Tools: Center Punches 4 mm, Drift Punches 3 / 4 mm, Flat Chisel 125 / 150 mm, Cross Cut Chisel 125 mm. Arranged in shakeproof soft foam inlay 156 (L) x 104 (W) x 60 (H).



ART. CODE **8150 0719** **39.95 €**

Ratchet Set



Reversible Ratchet with lever, 72 teeth, with safety lock, Sliding Handle 115 mm, Extensions 50 / 100 mm, Universal Joint, Spinner Handle 150 mm.



ART. CODE **8150 2061** **6 72 6,3 mm 1/4** **39.95 €**

Mini Ratchet with bits



32-pc. bit set with Mini-Bit Ratchet for confined spaces incl. power shank adaptor and 30 Bits made of S2 material with color guide system:
 3 - 4 - 5 - 6 mm PH 1 - 2 x PH 2, 2 x PH 3;
 PZ 1 - PZ 2 - PZ 3; 3 - 4 - 5 - 6, T10 - T15 - T20 T25 - T27 - T30 - T40;
 10 - T15 - T20 T25 - T27 - T30 - T40.
 Arranged in shakeproof soft foam inlay 156 (L) x 104 (W) x 60 (H).



ART. CODE **8150 7052** **6 72 6,3 mm 1/4** **39.95 €**

Socket Set



17-pc. set of sockets, 6-point, with SmartDrive-Profile, 6-22 mm. Arranged in shakeproof soft foam inlay 156 (L) x 104 (W) x 60 (H).



10 mm 3/8 3075 6 - 7 - 8 - 9 - 10 - 11 - 12 - 13 - 14 - 15 - 16 - 17 - 18 - 19 - 20 - 21 - 22 mm

ART. CODE **8150 3075** **21.95 €**

Socket Set



15-pc. set of sockets, 6-point, with SmartDrive-Profile, 6-22 mm. Arranged in shakeproof soft foam inlay 156 (L) x 104 (W) x 60 (H).



12,5 mm 1/2 4075 8 - 9 - 10 - 11 - 12 - 13 - 14 - 15 - 16 - 17 - 18 - 19 - 20 - 21 - 22 mm

ART. CODE **8150 4075** **24.95 €**

HIT deals

Our classics at the best price.

■ SPANNERS



- ✓ High Industrial Quality
- ✓ For 24/7 usage
- ✓ Dimensionally accurate, precise and stable: for safe working



All 8 and 12 pcs sets in stable premium rollbag with water-resistant surface and comfortable Velcro straps.



Protective packaging in our new window box, ideal for storage.

■ Double Open Ended Spanners, DIN 3110



Ideal for stud bolts.
With flat heads.

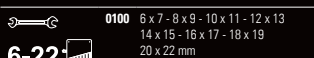

ART. CODE 0100 9080 **21.95 €**

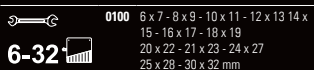

ART. CODE 0100 9120 **35.95 €**

■ Combination Spanners, DIN 3113 A



With angled ring side.

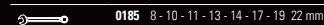

ART. CODE 0185 9080 **29.95 €**

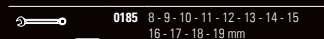

ART. CODE 0185 9123 **38.95 €**

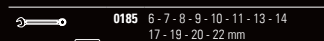

ART. CODE 0185 9120 **38.95 €**

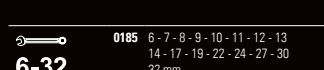

ART. CODE 0185 9160 **69.95 €**

■ Combination Spanners, DIN 3113 B, offset



With offset ring side for deep-set screw joints.

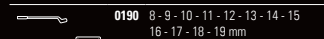

ART. CODE 0190 9120 **49.95 €**

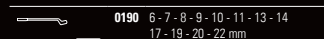

ART. CODE 0190 9121 **49.95 €**

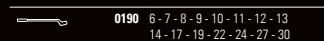

ART. CODE 0190 9160 **89.95 €**

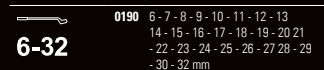

ART. CODE 0190 9260 **149.95 €**

■ Double Ended Ring Spanners, DIN 838



With deeply offset double ring profile.

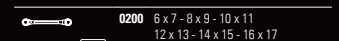

ART. CODE 0200 9080 **32.95 €**

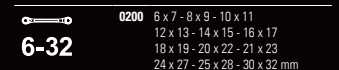

ART. CODE 0200 9120 **69.95 €**

HIT deals

Our classics at the best price.

■ RATCHET SPANNERS

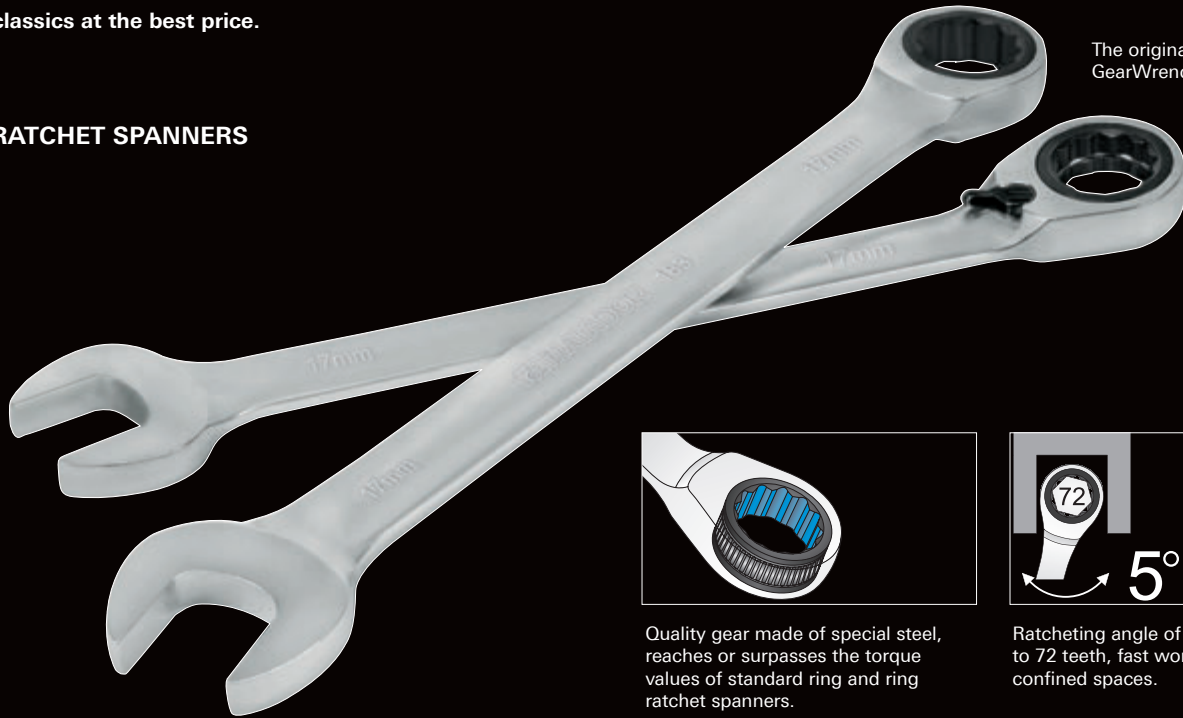

The original with patented GearWrench[®]-gear.

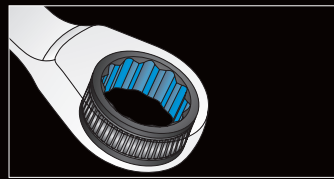

Quality gear made of special steel, reaches or surpasses the torque values of standard ring and ring ratchet spanners.



Ratcheting angle of only 5° thanks to 72 teeth, fast work even in confined spaces.

■ Combination Ratchet Spanners, straight

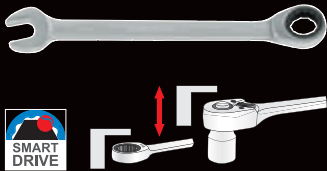

Straight type, without switch lever, end position 15° angled, MATADOR SUPER CHROM, CrV-Steel.

	0183 8 - 10 - 13 - 17 - 19 mm		
8-19			
ART. CODE		39.95 €	
0183 8 - 9 - 10 - 11 - 12 - 13 - 14 - 15 - 16 - 17 - 18 - 19 mm			
8-19			
ART. CODE		79.95 €	
0183 6 - 7 - 8 - 10 - 11 - 12 - 13 - 14 - 15 - 16 - 17 - 19 mm			
6-19			
ART. CODE		79.95 €	
0183 9121			

■ Combination Ratchet Spanners, straight, XL



For large fittings in industry, agriculture, commercial vehicle technology, etc.

	0183 27 - 30 - 32 mm		
27-32			
ART. CODE		89.95 €	
0183 9030			

■ Combination Ratchet Spanners, angled



Similar to 183 series, but angled and with switch lever for comfortable working.

	0189 8 - 10 - 13 - 17 - 19 mm		
8-19			
ART. CODE		49.95 €	
0189 8 - 9 - 10 - 11 - 12 - 13 - 14 - 15 - 16 - 17 - 18 - 19 mm			
8-19			
ART. CODE		99.95 €	
0189 6 - 7 - 8 - 10 - 11 - 12 - 13 - 14 - 15 - 16 - 17 - 19 mm			
6-19			
ART. CODE		99.95 €	
0189 9121			

■ 4in1 Ratchet Spanner



Suitable for 70% of all screw tasks.



2 sizes per side, simply turn for bi-directional tightening.

	0184 10 - 13 - 17 - 19 mm		
10-19			
ART. CODE		23.95 €	
0184 0001			

HIT deals

Our classics at the best price.



Adjustable Single Ended Spanners with scale (mm)

Extra polished heads for precise adjustment of the jaws.

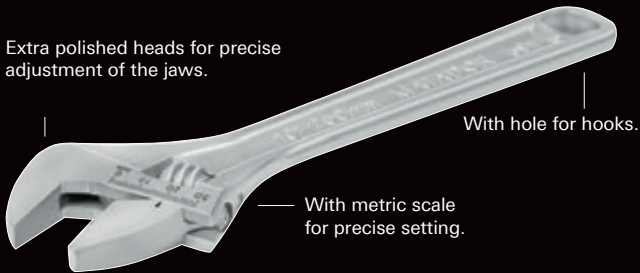

With hole for hooks.

With metric scale for precise setting.

ab 4.95 €



ART. CODE	mm			€
	mm	mm	*	
0591 0040	1-13	100	4	4.95
0591 0060	1-20	150	6	6.95
0591 0080	1-24	200	8	7.95
0591 0100	1-30	250	10	8.95
0591 0120	1-34	300	12	9.95
0591 0150	1-43	375	15	17.95

Torque Wrench ECO



With calibration certificate according to DIN EN ISO 6789.

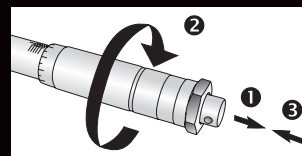

Simple adjustment by pushing and pulling the locking knob at the end of the handle.



Integrated ratchet.

22 - 350 N.m.

Robust steel handle.

ART. CODE	mm / *	N-m	lbf-ft	€
6172 0010	10	22 - 110	2,2 - 11	49.95
6172 0020	12.5	42 - 210	4,2 - 21	59.95
6172 0030	12.5	70 - 350	7 - 35	89.95

HIT deals

Our classics at the best price.

All major sockets and bits in a smart set. The SMARTY-Box compact.

SMARTY-Box compact 47 pcs

Professional bit holder with magnetic and mechanic interlock.



Compact size, only 145 x 95 mm, fits into almost every place, even in your desk.

MFS MATADOR FOAM SYSTEM.



SMART² DRIVE

With metal handle and 72 teeth precision gear technology.



With 30 standard bits (25 mm) and extra long screwdriver bits (75 mm) with color guide system for quick identification.

6,3 mm 1/4 72



With 4 functions:

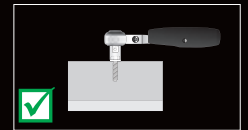

Fine-toothed reversible ratchet.

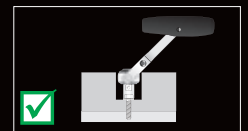

Special applications ratchet.

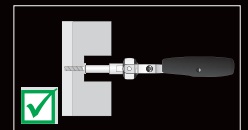

Screwdriver with ratchet function.

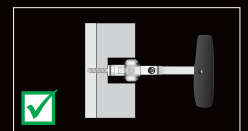

T-Handle for high torque transmission.

SMARTY BOX

With Multi-Ratchet.

Classic:

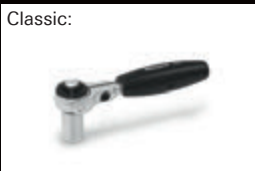

Or so:



And so:



Or so:



So as well:

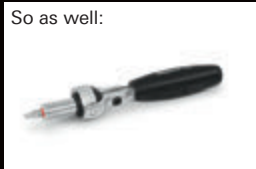

And so:



	6,3 mm 1/4	2063	Reversible Ratchet
	6,3 mm 1/4	2065	6,3 mm 1/4 50 mm
	6,3 mm 1/4	2075	6 - 7 - 8 - 9 - 10 - 11 - 13 mm
	6,3 mm 1/4	2084	6,3 mm 1/4
	6,3 mm 1/4	7026	3 - 3.5 - 4.5 - 5.5 - 6.5 x 25 mm, 4 - 6 x 75 mm
	6,3 mm 1/4	7027	PH 0 - PH 1 - PH 2 - PH 2 - PH 3 x 25 mm PH 1 - PH 2 x 75 mm
	6,3 mm 1/4	7027	PZ 0 - PZ 1 - PZ 2 - PZ 2 - PZ 3 x 25 mm
	6,3 mm 1/4	7028	3 - 4 - 5 - 6 x 25 mm
	6,3 mm 1/4	7033	T6 - T7 - T8 - T9 - T10 - T15 T20 - T25 - T27 T30 - T40 x 25 mm, T25 - T30 x 75 mm
	6,3 mm 1/4	7047	6,3 mm 1/4
ART. CODE	47	69.95 €	
2155 0001			

HIT deals

Our classics at the best price.



MATADOR Sockets 6 Stars-Comfort



Chrome Vanadium Steel for high tenacity, exceeds temper values demanded according to DIN.



SUPER CHROM coating for perfect rust protection, cannot flake off.



Double Smart Drive profile both on hexagon and square side is gentle on the screw. And what's even more important: On the ratchet.

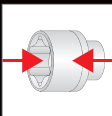

Double coating inside and outside, does not transfer surface rust.



Stamped mark (not only lasered) for permanent identification and manufacturer's notification.

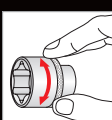

Knurled zone for manual high-speed turning even with oily fingers.

Socket Set 16 pcs



- With fine-toothed reversible ratchet
- In solid metal case, durable quality, black powder coated

2061 Reversible Ratchet

2064 115 mm

2065 **2065** 100 mm

2068 **2068**

2073 150 mm

2075 4 - 4.5 - 5 - 5.5 - 6 - 7 - 8 - 9 - 10 - 11 - 13 mm

ART. CODE **2115 9160** **59.95 €**

Socket Set 28 pcs



- With fine-toothed reversible ratchet
- In solid metal case, durable quality, black powder coated

2061 Reversible Ratchet

2064 115 mm

2065 **2065** 50, 100 mm

2068 **2068**

2073 150 mm

2075 4 - 4.5 - 5 - 5.5 - 6 - 7 - 8 - 9 - 10 - 11 - 13 mm

2076 4 - 5.5 - 7 x 32 mm

2077 PH 1 - PH 2 - PH 3 x 32 mm

2078 3 - 4 - 5 - 6 - 8 x 32 mm

ART. CODE **2135 9280** **69.95 €**

Socket Set 21 pcs



3061 Reversible Ratchet

3065 **3065** 125, 250 mm

3068 **3068**

3075 6 - 7 - 8 - 9 - 10 - 11 - 12 - 13 - 14 - 15 - 16 - 17 18 - 19 - 20 - 21 - 22 mm

ART. CODE **3115 9210** **99.95 €**

ART. CODE **3115 9211** **99.95 €**

Socket Set 39 pcs



3061 Reversible Ratchet

3065 **3065** 125, 250 mm

3068 **3068**

3075 6 - 7 - 8 - 9 - 10 - 11 - 12 - 13 - 14 - 15 - 16 - 17 18 - 19 - 20 - 21 - 22 mm

3078 4 - 5 - 6 - 7 - 8 - 10 x 48 mm

3090 E8 - E10 - E11 - E12 - E14

3092 T15 - T20 - T25 - T27 - T30 - T40 - T45 x 48 mm

ART. CODE **3125 9390** **129.95 €**

ART. CODE **3125 9391** **129.95 €**

HIT deals

Our classics at the best price.



All sockets sets including the new **790**

■ **Socket Set**
23 pcs

1/2



			4061	Reversible Ratchet		
			4064	300 mm		
			4065			125, 250 mm
			4068			
			4075	10 - 11 - 12 - 13 - 14 - 15 - 16 - 17 - 18 - 19 - 20 21 - 22 - 23 - 24 - 27 - 30 - 32 mm		
						99.95 €
						99.95 €

■ **Socket Set**
61 pcs

1/4 1/2



			2061	Reversible Ratchet		
			2065			50 mm
			2068			
			2073	150 mm		
			2075	4 - 4.5 - 5 - 5.5 - 6 - 7 - 8 - 9 - 10 - 11 - 12 - 13 14 mm		
			2076	4 - 5.5 - 7 x 32 mm		
			2077	PH 1 - PH 2 x 32 mm		
			2077	PZ 1 - PZ 2 x 32 mm		
			2078	3 - 4 - 5 - 6 - 8 x 32 mm		
			2090	E4 - E5 - E6 - E8		
			2092	T10 - T15 - T20 - T25 - T27 - T30 x 32 mm		
			4061	Reversible Ratchet		
			4065			125, 250 mm
			4068			
			4075	10 - 11 - 12 - 13 - 14 - 15 - 16 - 17 - 18 - 19 - 20 21 - 22 - 23 - 24 - 27 - 30 - 32 mm		
						169.95 €
						169.95 €

■ **Screwdriver Bit Sockets**
(Hex) 9 pcs

1/2



			4078	5 - 6 - 7 - 8 - 10 - 12 - 14 - 17 - 19 x 62 mm		
						53.95 €

■ **Screwdriver Bit Sockets**
(TORX®) 9 pcs

1/2



			4092	T20 - T25 - T27 - T30 - T40 - T45 - T50 - T55 T60 x 62 mm		
						59.95 €

HIT deals

Our classics at the best price.

■ Fine-toothed Reversible Ratchets



For heavy duty use in industry and workshop. Chrome Vanadium steel, precisely hot forged. High performance gear technology with **precise 72 teeth** for only 5° swivel angle. **Very powerful** and strong due to 18 teeth in mesh during torquing, **reached over 1.600 N·m**. **Ergonomic handle** useable with both hands.

20 mm 3/4 5060 510 mm

ART. CODE
5060 0001

89.⁹⁵ €

■ Socket Set 16 pcs

3/4



- With **push-through ratchet 5062**
- 12 pieces of sockets 22 - 60 mm
- With black MFS soft foam inlay, resistant against oil and lubricants
- In solid metal case, durable quality, black powder coated

20 mm 3/4 5062 510 mm Durchstecknarre

20 mm 3/4 5064 500 mm

20 mm 3/4 5065 20 mm 3/4 200, 400 mm

20 mm 3/4 5075 22 - 24 - 27 - 30 - 32 - 36 - 38 - 41 - 46
50 - 55 - 60 mm

ART. CODE 5143 9163 **299.- €**

ART. CODE 5143 9164 **299.- €**

■ Socket Set 16 pcs

3/4



- With **reversible ratchet 5060**
- 12 pieces of sockets 22 - 60 mm
- With black MFS soft foam inlay, resistant against oil and lubricants
- In solid metal case, durable quality, black powder coated

20 mm 3/4 5060 510 mm Umschaltknarre

20 mm 3/4 5064 500 mm

20 mm 3/4 5065 20 mm 3/4 200, 400 mm

20 mm 3/4 5075 22 - 24 - 27 - 30 - 32 - 36 - 38 - 41 - 46
50 - 55 - 60 mm

ART. CODE 5143 9160 **319.- €**

ART. CODE 5143 9161 **319.- €**

■ Socket Set 14 pcs

1



- For trucks and heavy industry
- With push-fit bar handle, fine-toothed
- 10 pieces of sockets 36 - 80 mm
- In solid metal case, durable quality, black powder coated

25 mm 1 6060 610 mm Umschaltknarre

25 mm 1 6064 640 mm

25 mm 1 6065 40 mm 1 200, 400 mm

40 mm 1 6075 36 - 41 - 46 - 50 - 55 - 60 - 65 - 70 - 75 - 80 mm

ART. CODE 6144 9140 **699.- €**

HIT deals

Our classics at the best price.

Engineer's Hammers



- Induction hardened
- Handle fixed with round steel wedge and resin
- With safety collar (tapered)
- Standard: DIN 1041 / handle DIN 5111

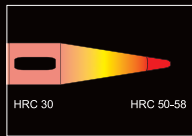

ART. CODE 0705 0500	500 g	9.95 €
ART. CODE 0705 1000	1000 g	15.95 €

Parallel Pin Punches 6 pcs



- Tempered striking head
- Very high strength values by using special chrome vanadium air hardening steel
- In practical plastic holder

ART. CODE 0718 9060	6	15.95 €
------------------------	---	----------------

Tool Set 6 pcs



- Tempered striking head
- Very high strength values by using special chrome vanadium air hardening steel
- In practical plastic holder

0714	125, 150 mm	
0715	125 mm	
0716	3, 4 mm	
0717	4 mm	
ART. CODE 0719 9060	6	18.95 €

Torque Wrenches UNO

3/4 1

- Small head to reach tiny spaces, lever ratchet with 48 teeth, safety lock and quick-release function
- Clearly audible and perceptible signal when the desired torque value is reached
- Extremely precise, maximum deviation only 3% from the set scale value
- For clockwise operation
- Ergonomic and hand-friendly 2-component handle
- Only one window with clear numeric value in N·m
- Error-free handling thanks to double-sided finger grooves



ART. CODE	mm / °	N·m	
6175 0750	20 3/4	150 - 750	499.- €
6175 1000	25 1	200 - 1000	599.- €

Torque Multipliers



No maintenance thanks to lifetime lubrication

With reaction arm

Heavy duty construction with planet gear mechanism with 3 precisely engineered gear stages and hardened gear wheels

ART. CODE	mm / °	mm / °	N·m	lbf-ft	Ratio	N·m	lbf-ft	mm	
6182 0010	20 3/4	25 1/2	1500	1100	1:5	300	220	108	599.- €
6182 0020	25 1	25 1/2	2700	2000	1:5	540	400	108	699.- €

HIT deals

Our classics at the best price.

■ SCREWDRIVERS / BITS

Burnished tip for precise, **durable fitting** into the screw.

Hard, black turning zone made of special plastic for **quick working** with low friction. **Soft** and anti-slip **grey grip zone** made of TPE plastic for **secure hold** with maximum pressure.

Identification at handle end.

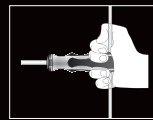

Hanging hole / T-handle mounting



Identification at handle end



■ Screwdriver Set 6 pcs



0615 0,6 x 4,0 x 75 - 0,8 x 5,0 x 100 1,0 x 5,5 x 125 1,2 x 6,5 x 150 mm

0655 PH 1 x 80 - PH 2 x 100 mm

ART. CODE **0680 9060** **24.95 €**

■ Screwdriver Set 8 pcs



0615 0,6 x 4,0 x 75 - 0,8 x 5,0 x 100 1,0 x 5,5 x 125 1,2 x 6,5 x 150 mm

0655 PH 1 x 80 - PH 2 x 100 mm

0635 Spannungsprüfer 0,5 x 3,0 x 65 mm

0640 Stubby-Schraubendreher 0,8 x 4,0 x 25 mm

ART. CODE **0680 9080** **27.95 €**

■ Profi Bit Assortment In Metal Box, 31 pcs



Compact industrial quality bitbox made of metal, bits with long life, with professional bit holder.

0,8 x 4,0 - 1,0 x 5,5

PH 1 (3x) - PH 2 (3x) - PH 3 (3x)

PZ 1 (3x) - PZ 2 (3x) - PZ 3 (3x)

T10 - T15 - T20 - T25 (2x)

T30 (2x) - T40 (2x)

6,3 (1/4) 60 mm

ART. CODE **7050 0001** **24.95 €**

■ Bitbox TORSION 32 pcs



Superior lifetime, equally suitable for cordless and impact screwdrivers. Absorbs the power peaks and thus ensures more elasticity.

3,0 - 4,0 - 5,0 - 6,0

PH 1 - PH 2 (2x) - PH 3

PZ 1 - PZ 2 (2x) - PZ 3

3 - 4 - 5 - 6

T10 - T15 - T20 - T25 - T27

T30 - T40

T10 - T15 - T20 - T25 - T27

T30 - T40

6,3 (1/4) 60 mm

6,3 (1/4)

ART. CODE **7052 0003** **19.95 €**

HIT deals

Our classics at the best price.

■ L-Key Wrenches

softGRIP

Especially soft and flexible TPE material for quick and easy removal.



Ergonomic, round form with extremely rounded edges for comfortable wearing or direct working without removal.

■ Short Type, 9 pcs, in Slide Box

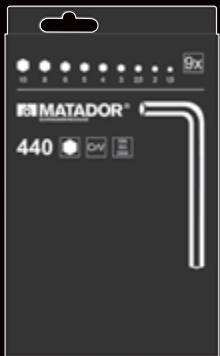

For hexagon socket screws, in plastic slide box, clearly arranged for quick removal.

0440 1.5-2-2.5-3-4-5-6-8
10 mm

ART. CODE 0440 9090 **6.95 €**

■ Short Type, 9 pcs, in a Holder

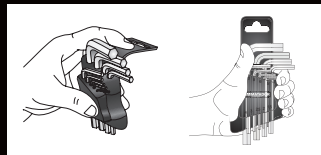

For hexagon socket screws, in black softGRIP-holder, fully hardened.

softGRIP 0440 1.5-2-2.5-3-4-5-6-8
10 mm

ART. CODE 0440 9091 **6.95 €**

■ Long Type, 9 pcs, with Ball Point Head, in a Holder

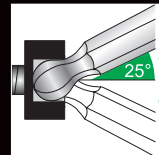

With ball point head on the long end, use in awkward areas, swivel angle up to 25°.

softGRIP 0442 1.5-2-2.5-3-4-5-6-8
10 mm

ART. CODE 0442 9091 **14.95 €**

■ Short Type, 8 pcs, TORX®, in a Holder



For inside TORX® screws, in black softGRIP-holder, fully hardened.

softGRIP 0443 T10-T15-T20-T25-T30-T40
T45-T50

ART. CODE 0443 9091 **9.95 €**

HIT deals

Our classics at the best price.

Professional Hacksaw



Ergonomic handle, rubberized on both sides

With high performance saw blade made of bi-metal HSS DMo5

- High blade tension of 100 kg for straight, clean cuts with precise joints
- Lightweight aluminum frame with steel core for easy handling
- Grip with integrated clamping mechanism

ART. CODE 440
0786 0002 mm **16.95 €**

Metal Saw Blade

High performance saw blade made of bi-metal HSS DMo5, 300 X 13 X 0,6 mm.

ART. CODE 300
0786 0003 mm **1.95 €**

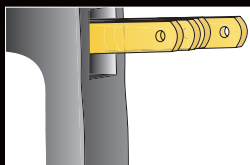

With reservoir for 9 saw blades.

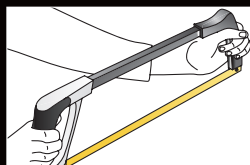

Ideal for two-hands operation.

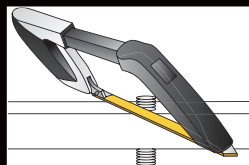

Alternative 55° blade alignment for a flush sawing of pins etc.

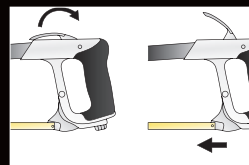

One-hand quick release mechanism.

Mini-Screwdriver 4in1



- 4 Screwdrivers in one tool
- In the handy form of a pen, with clip
- Suitable for home, hobby, toys, computers, glasses and any kind of small repairs
- Perfect combination of fine mechanics and standard screwdriver

4 penny

ART. CODE 1,5 - 3,0
0664 0001 PH 00 - PH 0 **3.95 €**

Screw Extractor Set 6 pcs



For extracting broken screws with right-hand thread and broken-off tube ends of fittings.

M3 - M24, 1/8 - 1"
ART. CODE 6
0771 0002 **11.95 €**

Grip Pliers



- For securely holding, clamping and tensioning round, profile and/or flat material

ART. CODE 250 mm
0588 0250 10" **9.95 €**

Steel Wire Brush with 5 rows



Bent type, with wooden handle, wire filled in 5 rows.

ART. CODE 290 mm
0782 0001 **2.25 €**

Quality Cable Knife with wooden handle



The classic cable knife for each tool assortment. The blade folds away, with straight, hardened blade and round cable scraper. Moulded handle made out of wood. Material: Stainless steel.

ART. CODE 200 mm
0825 0001 **9.95 €**

HIT deals

Our classics at the best price.

Automotive Tools



Four Way Rim Wrenches for cars

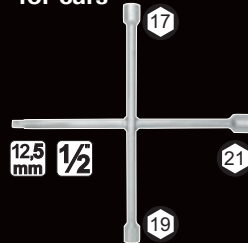

Welded version made out of chrome vanadium steel, with SK profile, works also on rounded nuts.

ART. CODE 0350 1001 **8.95 €**

Strap Wrenches Pro

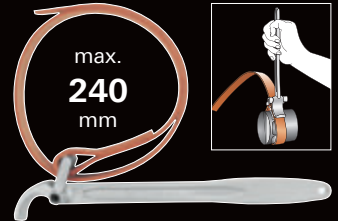

Heavy-duty construction for high torque values, for oil filters and other round shaped bodies.

ART. CODE 0426 0001 **29.95 €**

Wheel Bolt Cap Pliers



Special long flat nose pliers with notch, e.g. installing protective caps for aluminium wheel bolts, installation and removing blade fuses, comparable with VW 3314 / T20011.

ART. CODE 0585 0014 **7.95 €**

Tyre Levers



500 mm H-profile for high stability. For tire installation and removal, for steel and aluminium rims, also suitable for general purposes.

ART. CODE 0754 0003 **14.95 €**

Release Tool



For generic works on chassis, e.g. removing door panels, fixed door windows with window guide etc. Comparable with VW T10236.

ART. CODE 0842 0001 **7.95 €**

Spreader for shock absorbers



For spreading of the front shock absorber tube from the wheel bearing housing. Comparable with VW 3424.

ART. CODE 4078 0031 **7.95 €**

Multi Wedge

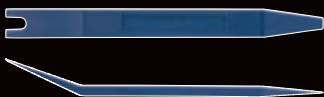

For removing panels, cover clips, carpets, etc. Very resistant material.



ART. CODE 0843 0004 210 mm **5.95 €**

Panel Removal Kit 5 pcs

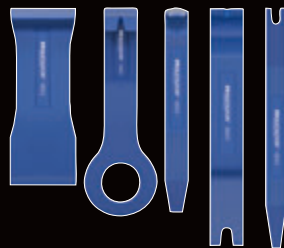

Professional trim and panel removal kit.

ART. CODE 0843 9050 **11.95 €**

Rust Remover MA 2000



Removes rust and all other fixed compounds on screws, nuts, iron railings, lattice towers, etc. Effective wear and corrosion protection.

ART. CODE 8146 0001 500 ml **4.95 €**

Brake Cleaner



Ideal as a universal cleaner. Cleans brake and clutch parts without dismantling, removes brake fluid, oil, dust, etc.

ART. CODE 8146 0002 500 ml **4.95 €**

Pneumatic Tools.

Still working when others have long given up.

High Performance Impact Wrenches



- EXTREMELY LOW NOISE.
- EXTREMELY LIGHT.
- EXTREMELY POWERFUL.

High-performance impact wrench with outstanding technical features. Extremely powerful, light and quiet. Twin hammer clutch mechanism with 6-blades rotor. **Cold-insulated, non-slip handle.** Ultra light **composite housing.** One-hand switchover. Extremely **low vibration**, ideal for continuous operation. Low air consumption. Exhaust air guided downwards through the handle. Including coupler.

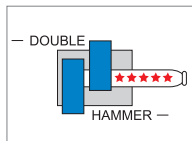

ART. CODE	N-m	N-m	dB(A)	U/min	l/min	m/s ²	mm (")	kg	
7000 0001	12.5 mm 1/2	1.490	813	83	7.000	113	10 (3/8)	1,9	199.- €
7000 0002	20 mm 3/4	3.200	1.898	90	5.500	198	13 (1/2)	3,3	399.- €
7000 0003	25 mm 1	3.200	1.898	90	5.500	198	13 (1/2)	3,4	449.- €

Impact Wrench „MiniMAX“



High-performance impact wrench with outstanding technical features. **Extremely small** (only 98 mm length), **extremely powerful 1.275 N-m loosening torque, light and low noise.** Jumbo hammer clutch. **Cold-insulated, non-slip handle.** Ultra light **composite housing.** One-hand switchover. Extremely **low vibration**, ideal for continuous operation. Low air consumption. Exhaust air guided downwards through the handle. Including coupler.

1.275 N-m

High Performance Impact Wrench „FatCat“



High-performance impact wrench with outstanding technical features. Extremely powerful, light and quiet. Twin hammer clutch mechanism with 6-blades rotor. **Cold-insulated, non-slip handle.** Ultra light **composite housing.** Enormous **3.389 N-m** loosening torque. Only 96 dB (A) sound pressure level. Only 6.5 kg weight due to composite housing. With long anvil 180 mm (3"). Complete with side handle with mounting kit. Including coupler.

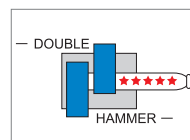

N-m	N-m	dB(A)	U/min	l/min	m/s ²	mm (")	kg	
1.275	678	94	10.000	164	7,3	10 (3/8)	1,27	
ART. CODE	12.5 mm 1/2	149.- €						
7000 0011								

N-m	N-m	dB(A)	U/min	l/min	m/s ²	mm (")	kg	
3.389	2.441	96	6.000	282	12,9	13 (1/2)	7,3	
ART. CODE	25 mm 1	599.- €						
7000 0004								



4-255 mm.

MATADOR's wide range of pneumatic tools: Impact sockets for industrial users from 4 to 255 mm. Not just hot air. Please take a look.



Die Grinder, straight



Collet 6 mm. With continuous power regulator for variable speed adjustment depending on the case of application. Including coupler.

dB(A)	U/min	l/min	m/s ²	mm (*)	kg
79	20.000	113	0,46	10 (3/8)	0,7

ART. CODE 7004 0001 **99.95 €**

Micro Die Grinder



Collet 3 mm. With continuous power regulator for variable speed adjustment depending on the case of application. Including coupler.

dB(A)	U/min	l/min	m/s ²	mm (*)	kg
79	56.000	113	0,13	10 (3/8)	0,4

ART. CODE 7004 0002 **99.95 €**

Air Duster



For cleaning and removing of swarfs and other particles. Anti-slip handle made of special plastic. Steel nozzle. Adjustable air volume. With hanging hole. Can be connected directly to air coupling.

dB(A)	U/min	l/min	bar	mm (*)	kg
88	15	300	5-8	10 (3/8)	0,1

ART. CODE 7003 0001 **11.95 €**

Impact sockets, short type, 14 pcs



Set of impact sockets, short type. With MATADOR SmartDrive²-Profile. Including safety rings and pins. In solid metal case with softfoam inlay.

Collet	Profile	ART. CODE	Dimensions
12,5 mm	1/2	7475	10 - 11 - 13 - 14 - 15 - 17 - 19 - 21 - 22 - 24 x 38 mm
12,5 mm	1/2	7499	1x 10 - 14 / 1x 15 - 32

ART. CODE 7475 9001 **59.95 €**

Impact sockets, long type, 13 pcs



Set of impact sockets, long type. With MATADOR SmartDrive²-Profile. Including safety rings and pins. In solid metal case with softfoam inlay.

Collet	Profile	ART. CODE	Dimensions
12,5 mm	1/2	7481	10 - 13 - 15 - 17 - 18 - 19 - 21 - 22 - 24 x 78 mm
12,5 mm	1/2	7499	1x 10 - 14 - 1x 15 - 32

ART. CODE 7481 9001 **79.95 €**

Impact sockets, 17 pcs



Set of impact sockets, short and long type. With MATADOR SmartDrive²-Profile. Including safety rings and pins. In solid metal case with softfoam inlay.

Collet	Profile	ART. CODE	Dimensions
20 mm	3/4	7575	17 - 19 - 22 - 24 - 27 - 30 - 32 x 50 mm
20 mm	3/4	7581	17 - 19 - 22 - 24 - 27 - 30 - 32 - 33 x 90 mm
20 mm	3/4	7599	1x 17 - 46 - 1x 17 - 46

ART. CODE 7575 9001 **169.95 €**

New pliers is what the country needs.
With 3-component sleeves and many special features.



3KsoftGRIP

The new MATADOR pliers with **3KsoftGrip** sleeve provide an improved grip as you work thanks to its 3 components. The tailored shape of the handles and the combination of different, environmentally friendly materials make the pliers lie optimally in your hand. The ergonomically designed 3KsoftGrip handle with its **triple-zone** blend of handle textures ensures strain-free working. For increased safety, the tools feature an optimised shape to prevent hands slipping off the tool and an eyelet for retaining straps to secure the pliers when working on a roof, scaffolding or construction site.

Combination Pliers

For gripping, cutting und holding work. For cutting hard and soft wires. Inductively hardened cutting edges. Asymmetric inside jaws for better grip on the workpiece. Gripping zones for flat and round materials. With nail and wire holder and integrated ring spanner. Power transmission with optimum leverage for easy and effortless work. 3KsoftGrip handles.

ART. CODE
0500 0180  **0500** 180 mm (7")

18.95 €



Side Cutter

For cutting hard and soft wires. Precision cutting edges for the finest wires. Inductively hardened cutting edges. Hardness of cutting edges approx. 62 HRC. Power transmission with optimum leverage for easy and effortless work. With ergonomically shaped 3KsoftGrip handle. DIN ISO 5749.

ART. CODE
0532 0160  **0532** 160 mm (6.1/4")

18.95 €



Heavy Duty Side Cutter

More powerful. Precision cutting edges for piano wire (D2 quality). Inductively hardened cutting edges. Power transmission with optimum leverage for easy and effortless work. With ergonomically shaped 3Ksoft-Grip handle. DIN ISO 5749.

ART. CODE
0530 0180  **0530** 180 mm (7")

21.95 €



Chain Nose Pliers

For holding, gripping, bending and cutting work. For cutting hard and soft wires. With cutting edge and burner hole. Inductively hardened cutting edges. Serrated inside jaws. With long flat-round jaws. Integrated ring spanner. With ergonomically shaped 3KsoftGrip handle. DIN ISO 5745.

ART. CODE
0585 0170  **0585** 170 mm (6.3/4")

17.95 €

ART. CODE
0585 0205  **0585** 205 mm (8")

20.95 €



ART. CODE
0586 0205  **0586** 205 mm (8")

20.95 €



Pliers set, 3 pcs

Practical set with the most important pliers: Combination Pliers 180 mm, Heavy Duty Side Cutters 180 mm and Chain Nose Pliers with straight jaws 205 mm.

ART. CODE
0500 9030  **0500** 180 mm (7")
 **0530** 180 mm (7")
 **0585** 205 mm (8")

59.95 €



Forged, not casted.

Manufactured for generations. Our classic.

Parallel Bench Vices



The classic for every workshop: Parallel bench vices **completely forged from high-quality steel** with **inductively hardened, polished and knurled jaws**. Big, **hardened anvil**. Rolled, twin start trapezoid thread for precise and quick operation. **Integrated pipe-gripping jaws**. Spindle bearing protected against dirt and damage. Jaw opening capacity higher than jaw width for more comfortable operation. Delivery **including rotary base**.



With integrated pipe-gripping jaws.



Adjustable spindle guides for backlash-free operation.



Rotary base easy to fix and remove.



Steel arm easy to remove.

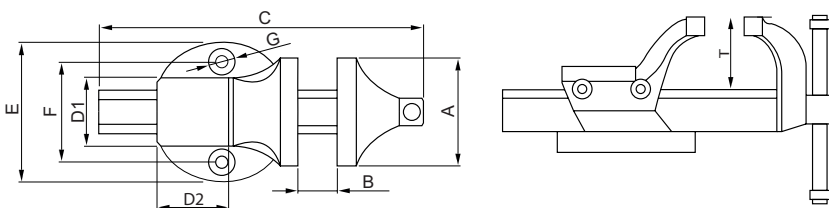

ART. CODE	A mm	T mm	B mm	D1 x D2 mm	C mm	E mm	F mm	G mm	kg	
0817 0100	100	60	105	60 x 64	350	122	89	10,5	6,4	99.- €
0817 0125	125	75	130	72 x 72	385	150	108	14,0	11,6	149.- €
0817 0150	150	95	160	96 x 90	490	180	139	16,5	21,0	199.- €

MATADOR Tool Cases.

Ideal for work, home and hobby.

Tool Assortment Allround, 81 pcs 6,3 $\frac{1}{4}$ 12,5 $\frac{1}{2}$

The 81-pc. tool assortment **Allround** in a solid plastic case contains the most important hand tools for small repairs on the job, at home or wherever you are. Thanks to the softfoam inlay the tools are arranged in a shakeproof way and do not fall off during transport.



- ☑ Full socket set in 6,3(1/4) - 12,5(1/2) with the most important sockets incl. TORX®
- ☑ Adjustable wrench
- ☑ Hex Keys 1,5 - 10 mm
- ☑ 3C combination pliers
- ☑ Ratchet screwdriver with exchangeable blades, etc.



Content:

	6,3 $\frac{1}{4}$	2061
	6,3 $\frac{1}{4}$	2064
	6,3 $\frac{1}{4}$	2065 50, 100 mm
	6,3 $\frac{1}{4}$	2068
	6,3 $\frac{1}{4}$	2073 150 mm
	6,3 $\frac{1}{4}$	2075 4 - 4,5 - 5 - 5,5 - 6 - 7 - 8 - 9 - 10 - 11 - 12 - 13 - 14 mm
	6,3 $\frac{1}{4}$	2076 4 - 5,5 - 7 x 32 mm
	6,3 $\frac{1}{4}$	2077 PH 1 - PH 2 - PH 3 x 32 mm
	6,3 $\frac{1}{4}$	2078 3 - 4 - 5 - 6 - 8 x 32 mm
	6,3 $\frac{1}{4}$	2090 E4 - E5 - E6 - E7 - E8 - E10 - E11
	6,3 $\frac{1}{4}$	2092 T8 - T10 - T15 - T20 - T25 - T27 - T30 - T40 x 32 mm
	12,5 $\frac{1}{2}$	4061
	12,5 $\frac{1}{2}$	4065 125, 250 mm
	12,5 $\frac{1}{2}$	4068
	12,5 $\frac{1}{2}$	4075 10 - 11 - 12 - 13 - 14 - 15 - 16 - 17 - 18 - 19 - 20 - 21 - 22 mm
	2K	0440 1,5 - 2 - 2,5 - 3 - 4 - 5 - 6 - 8 - 10 mm
	2K	0500 165 mm
		0591 205 mm / 8" (0-24 mm)
		0635 0,5 x 3,0 x 65 mm
		0672 PZ 1 x PZ 2 - PH 1 x PH 2 - PH 3 x 1,2 x 6,5 0,8 x 4,0 x 1,0 x 5,5 mm
		0705 300 g
		0797 2 m
		0827

ART. CODE 4145 9120

299.- €

Tool Assortment Automotive, 103 pcs 6,3 $\frac{1}{4}$ 12,5 $\frac{1}{2}$

The 103-pc. tool assortment **Automotive** is the ideal compilation of sockets and screwdriver sockets for all kind of car repair and maintenance work in industrial areas. Thanks to the softfoam inlay the tools are arranged in a shakeproof way and do not fall off during transport.



- ☑ Full socket set in 6,3(1/4) - 12,5(1/2) with the most important sockets from 4 - 32 mm
- ☑ Extensive assortment of screwdriver sockets (short and long type) including TORX®
- ☑ Spark Plug Sockets 14 - 20,8 mm, etc.

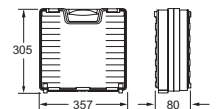

Content:

	6,3 $\frac{1}{4}$	2061
	6,3 $\frac{1}{4}$	2064
	6,3 $\frac{1}{4}$	2065 50, 100 mm
	6,3 $\frac{1}{4}$	2068
	6,3 $\frac{1}{4}$	2073 150 mm
	6,3 $\frac{1}{4}$	2075 4 - 4,5 - 5 - 5,5 - 6 - 7 - 8 - 9 - 10 - 11 - 12 - 13 - 14 mm
	6,3 $\frac{1}{4}$	2076 4 - 5,5 - 7 x 32 mm
	6,3 $\frac{1}{4}$	2077 PH 1 - PH 2 - PH 3 x 32 mm
	6,3 $\frac{1}{4}$	2078 3 - 4 - 5 - 6 - 8 x 32 mm
	6,3 $\frac{1}{4}$	2090 E4 - E5 - E6 - E7 - E8 - E10 - E11
	6,3 $\frac{1}{4}$	2092 T8 - T10 - T15 - T20 - T25 - T27 - T30 - T40 x 32 mm
	10 $\frac{3}{8}$	3081 14 - 16 - 18 - 20,8 mm
	12,5 $\frac{1}{2}$	4061
	12,5 $\frac{1}{2}$	4065 125, 250 mm
	12,5 $\frac{1}{2}$	4068
	12,5 $\frac{1}{2}$	4075 10 - 11 - 12 - 13 - 14 - 15 - 16 - 17 - 18 - 19 - 20 - 21 - 22 - 23 - 24 - 27 - 30 - 32 mm
	12,5 $\frac{1}{2}$	4078 4 - 5 - 6 - 7 - 8 - 10 - 12 - 14 x 62 mm 6 - 7 - 8 x 100 mm
	12,5 $\frac{1}{2}$	4082 12,5 (1/2) - 10 (3/8)
	12,5 $\frac{1}{2}$	4090 E10 - E12 - E14 - E16 - E18 - E20 - E22 - E24
	12,5 $\frac{1}{2}$	4092 T20 - T25 - T27 - T30 - T40 - T45 - T50 - T55 - T60 x 62 mm T30 - T40 - T45 x 100 mm

ART. CODE 4150 9120

289.- €

There are many tool cases in the market.

But only very few with high quality tools in a compact, full and uncompromising set.



BlackBox.



Shakeproof arrangement of the tools in soft foam inlays.



High functionality and easy-to-open intermediate plate.



High quality case „Made in Germany“ in a compact design.



Solid polypropylene construction with wide and rubberized handle.

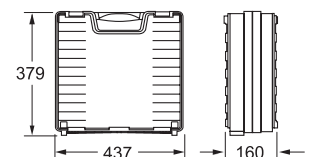

The most important 125 high quality hand tools for work, home and hobby in one case.

Compact. Complete. Uncompromising.



4in1 GearWrench® ring ratchet spanners - the original.



High-quality ratchets, e.g. 12.5 (1/2) with torque exceeding 750 Nm.



Sockets in 5 star industrial quality with SUPER CHROM surface.



Innovative pliers set with 3KsoftGRIP handles and many special features.



High-quality screwdrivers set with ergonomic 2C handles.



Including SMARTY-Box, our practical universal socket box.



For more information please use the QR-code.

Everything included. Only high quality hand tools.



The MATADOR „BlackBox“ is a real surprise box. It contains everything a demanding and ambitious (hobby) mechanic needs for **large and small repairs and maintenance**. Thought-out compilation of tools, uncompromising quality and **many multifunctional tools**, e.g.:

- **4-pc pliers set with 3KsoftGRIP handles** incl. allround side cutter for cutting, stripping, crimping and bending work
- **4in1 pocket screwdriver** with pocket clip and the 4 most important screwdriver bits for slotted and cross-slotted (PH) screws incl. fine mechanics bits for glasses, mobile phone, keyboard, radio, etc.

- **4in1 ring ratchet spanner**, suitable for 70% of all screwing work
- **6.3(1/4) SMARTY-Box** including the MATADOR multi ratchet which combines T-handle, screwdriver, ratchet and special ratchet for confined spaces in one tool
- **2 hex key sets** for hexagon socket and TORX screws with softGRIP holder for quick key removal

Shake-proof tool storage thanks to soft foam inlay that keeps all tools in place during transport. In well-designed and stable plastic case.

Content:

		0184	10 - 13 - 17 - 19 mm				2063			
		0185	8 - 10 - 11 - 13 - 14 - 17 - 19 - 22 mm				2065			50 mm
		0442	1,5 - 10 mm L				2075	6 - 7 - 8 - 9 - 10 - 11 13 mm		
		0443	T10 - T50				2084			
	3K	0500	165 mm (6.1/2")				2085			
	3K	0553	190 mm (7.1/2")				7026	3 - 3,5 - 4,5 - 5,5 - 6,5 x 25 mm, 4 - 6 x 75 mm		
	3K	0585	205 mm (8")				7027	PH 0 - PH 1 - PH 2 PH 2 - PH 3 x 25 mm PH 1 - PH 2 x 75 mm		
	3K	0556	240 mm (9.1/2")				7027	P2 0 - P2 1 - P2 2 P2 2 - P2 3 x 25 mm		
		0660	0,5 x 3,0 x 100 mm				7028	3 - 4 - 5 - 6 x 25 mm		
		0615	0,8 x 5,0 x 100 mm, 1,0 x 5,5 x 125 mm, 1,2 x 6,5 x 150 mm				7033	T6 - T7 - T8 - T9 - T10 - T15 T20 - T25 - T27 - T30 T40 x 25 mm T25 - T30 x 75 mm		
		0655	PH 0 x 60 mm, PH 1 x 80 mm PH 2 x 100 mm				7047			
		0635	0,5 x 3,0 x 65 mm				4061			
		0664	1,5 - 3,0 - PH 00 - PH 0				4064	300 mm		
		0705	300 g				4065	125 - 250 mm		
		0714	150 mm				4068			
		0717	4 x 120 x 10 mm				4075	10 - 11 - 12 - 13 - 14 - 15 16 - 17 - 18 - 19 - 22 - 24 27 - 30 - 32 mm		
		0718	∅ 3 - 4 - 5 - 6 mm				4085			
		0775	150 mm				4081	16 - 18 - 20,8 mm		
		0784	270 g Neodym				7110	XL (9)		
		0787	250 mm							
		0798	5 m							
		0828	170 mm							

ART. CODE
4152 0001



499.- €

MATADOR VDE tools.

Safety first.



VDE Torque Wrenches



Precise torque wrench with dip insulation according to IEC 60900 for all work under voltage of AC 1000 V and DC 1500 V. Insulation dipped in various layers with 2-layer safety dip insulation (red/yellow). **Tolerance only ±4%** of the set scale value. Precise reading accuracy for a minimum of 5,000 tightening cycles. For controlled clockwise tightening. Untightening with extra high loosening torque. Scale in N·m with large window. Clearly audible and perceptible signal when the desired torque value is reached. **Solid ratchet mechanism** with 30 teeth. With **German calibration certificate** according to DIN EN 6789:2003 Type II Class A. **Easy re-calibration.**

ART. CODE	mm /"	N·m	l mm	g	
6179 0025	10 $\frac{3}{8}$	5 - 25	205	410	299.⁹⁵ €
6179 0100	12.5 $\frac{1}{2}$	20 - 100	460	1378	469.⁹⁵ €
6179 0200	12.5 $\frac{1}{2}$	40 - 220	530	1500	489.⁹⁵ €

1000 V



VDE Screwdriver Set, 6 pcs



6-pc. set of the most important VDE screwdrivers. With dual compound handles: Yellow, soft and anti-slip grip zone made of TPE plastic for secure hold with maximum pressure. Red, hard turning zone for quick working with low friction. High security through unique identification. **Insulated according to IEC 60900:2004.**

		0616	2,5 x 75 - 3,5 x 100 - 5,5 x 125 mm
		0635	0,5 x 3,0 mm
		0656	PH 1 - PH 2
ART. CODE		0681 1001	24.⁹⁵ €

1000 V



(without voltage tester)

VDE Pliers Set, 3 pcs



3-pc. set of VDE pliers: Combination Pliers, Side Cutter and Telephone Pliers (straight or bent type).

Combination Pliers for cutting hard and soft wires. Inductively hardened cutting edges. Gripping zones for flat and round materials. **With nail and wire holder. Integrated ring spanner.** Power transmission with optimum leverage for easy and effortless work. High security through unique identification. **Insulated according to IEC 60900:2004.**

	0500	180 mm	
	0532	180 mm	
	0585	205 mm (straight)	
ART. CODE		0501 1301	69.⁹⁵ €
	0500	180 mm	
	0532	180 mm	
	0586	205 mm (bent)	
ART. CODE		0501 1302	69.⁹⁵ €

1000 V



















For work under voltage.

Electrician's Tool Kit in ABS case, 50 or 51 pcs

Tool kit for **hybrid- and electric vehicle repair with 50 high quality tools**, e.g.:

- Single ended spanners 8 - 24 mm
- Adjustable Wrenches
- 3-pc. set of pliers VDE with telephone pliers, combination pliers and side cutter
- 6-pc. set of screwdrivers VDE
- 12,5(1/2) Socket Set VDE with sockets 8-22 mm
- Hex Keys with T-Handle VDE
- In practical ABS hardshell case with extra storage space
- Optional with torque wrench VDE 20-100 N·m

Content:

ABS Case	8130	495 x 410 x 175 mm
	0131	8 - 9 - 10 - 11 - 12 - 13 - 14 - 15 - 16 - 17 - 18 - 19 - 20 - 21 - 22 - 23 - 24 mm
	0591	250 mm / 10"
	0532	160 mm / 6.1/4" VDE
	0585	170 mm / 6.3/4" VDE
	0500	205 mm / 8" VDE
	0616	0,4 x 2,5 x 75 - 0,8 x 4 x 100 1,0 x 5,5 x 125 mm VDE
	0656	PH 0 - PH 1 - PH 2 VDE
	4161	Lever Ratchet VDE
	4165	 12,5  125, 250 mm VDE
	4175	8 - 9 mm VDE
	4181	10 - 11 - 12 - 13 - 14 - 15 - 16 - 17 - 18 - 19 - 20 - 21 - 22 mm VDE
	0449	4 - 5 - 6 - 8 mm VDE
	4178	10 x 70 mm VDE
ART. CODE	50	1,299.- €
8130 9550		
same as 8130 9550, additionally with torque wrench		
	6179	Torque Wrench 20 - 100 N·m VDE
ART. CODE	51	1,699.- €
8130 9551		



















Electrician's Tool Kit in metal case, 26 pcs

Allround tool kit for electricians, with 26 high quality tools, e.g.:

- Single ended spanners 10 - 19 mm
- Adjustable Wrenches
- 5-pc. set of pliers VDE with telephone pliers, combination pliers, side cutter, cable stripper and crimping pliers
- 6-pc. set of screwdrivers VDE
- Cable scissors VDE
- Universal soldering iron with soldering tin
- Digital Multimeter
- In practical tool box

Content:

Steel Case	8170	420 x 150 x 200 mm
	0131	10 - 11 - 12 - 13 - 14 - 17 - 19 mm
	0591	250 mm / 10"
	0500	180 mm / 7" VDE
	0532	160 mm / 6.1/4" VDE
	0572	190 mm / 7.1/2" VDE
	0576	160 mm / 6.1/4" VDE
	0585	170 mm / 6.3/4" VDE
	0616	0,5 x 3 x 100 - 0,8 x 4 x 100 - 1,0 x 5,5 x 125 1,2 x 6,5 x 150 mm VDE
	0635	0,6 x 3,5 x 100 mm
	0656	PH 1 - PH 2 VDE
	0826	180 mm VDE
	0744	140 mm VDE
	0798	5 m
	0879	Tin 1mm x 2,8 m
	0879	190 mm
	0881	Multimeter
ART. CODE	26	299.- €
8170 0701		



Men's Kitchen  [®]
by MATADOR.



A new world of tools by MATADOR.
Uncompromisingly good.

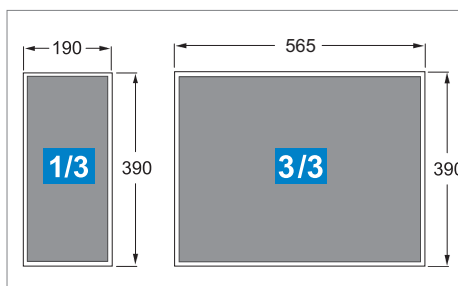

With standardized drawer dimensions - fit for all MATADOR MTS modules.



Select from more than 100 modules to find your perfect compilation.

Pre-configured or individually selected.

The smart modular system.

Fits in every room.

Brings order to your work environment.

Freely expandable.

Comfortable working height.

No drilling, no wall assembly.

High loading capacity.

Absolutely easy going.

Fully pre-assembled.

Solid metal construction.

Durable powder coating.

It is not only the single tool that counts: In a complex and increasingly digitally driven world it is getting even more important to have a place where you can be creative and where you can have the good experience to make something by hand.

For tool enthusiasts this place is the new **Men's Kitchen**® by MATADOR. **Men's Kitchen**® is not only a storage solution, it is a place where you will be inspired to create new things and where you will be highly motivated to „get the job done“.

Men's Kitchen  by MATADOR.

Our **pre-configured kitchen blocks** in different sizes fit into all rooms, from the broom closet up to the assembly hall. Thanks to its modular system the **Men's Kitchen**® is freely expandable and grows with your individual requirements.

The standardized drawer dimensions allow to include the professional MATADOR module system MTS into the **Men's Kitchen**® configuration so that all single tools will be in a perfect order.

With closets for power tools, storage boxes for all your individual small parts and our extensive program of accessories you can easily design your own world of tools, your own **Men's Kitchen**®.

Have fun!

3 star cuisine for real craftsmen. It`s served.

A little different kitchen.



✓ Extra high drawers for power tools and tool cases.



✓ Self-supporting construction, no drilling and wall assembly necessary.

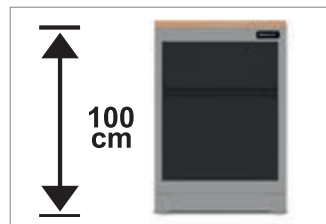

✓ Ergonomically optimal working height of 100 cm, with height adjustment screws.



✓ Cabinet with adjustable shelves available in 2 sizes.

Men's Kitchen[®]

by MATADOR.

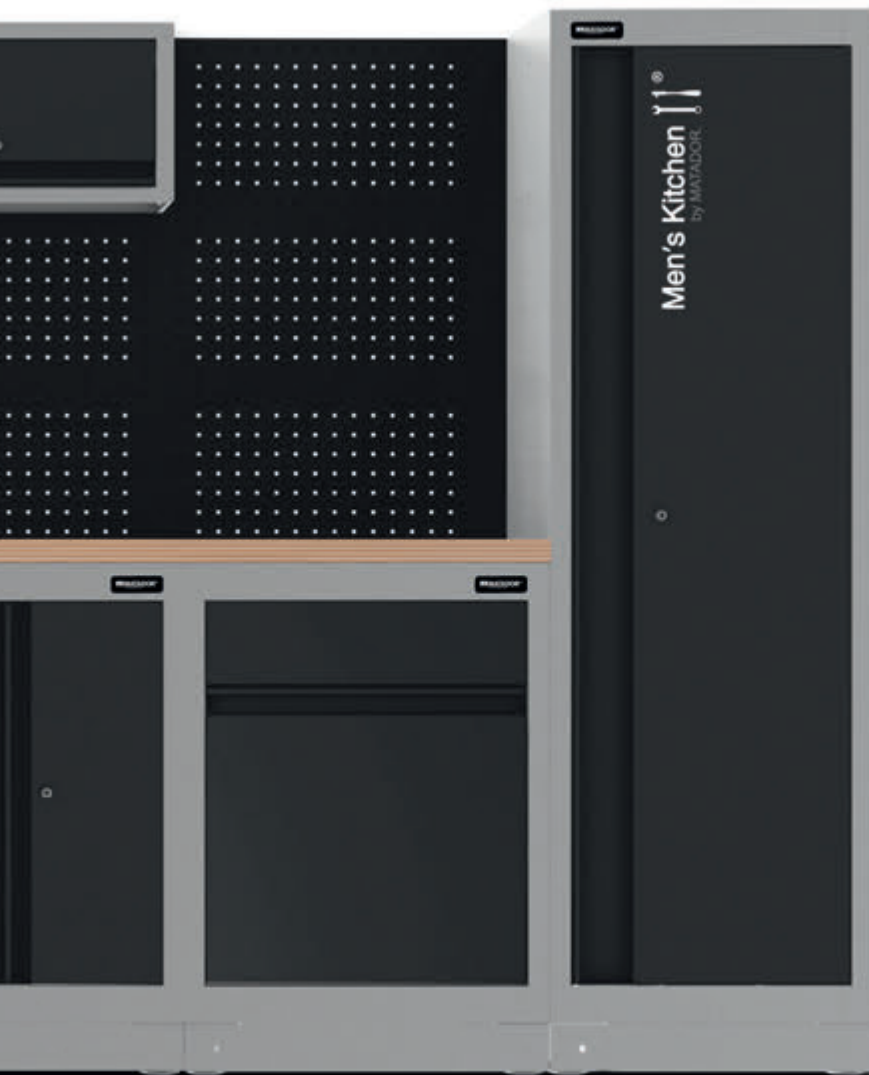

The **Men's Kitchen**[®] follows a clear principle: Simplicity.

Our **pre-configured kitchen blocks** allow a well thought-out and complete workshop arrangement without spending much time on planning and later on assembly.

The assembly of the **Men's Kitchen**[®] is really easy: All cabinets are fully pre-assembled so that you do not need to screw together all the single parts. You only need to assemble the side and middle brackets.

The self-supporting construction requires no drilling or wall assembly. Your **Men's Kitchen**[®] can easily be set up anywhere in your room.

It can't be easier than that:

- Select.
- Unpack.
- Set up.

Ready.



- Cupboard with gas spring available in 2 sizes.



- Ball-bearing drawer slides, 45 kg capacity, full extension, central lock.



- Perforated panels for hooks and accessories.



- Stainless steel or wooden worktop.

For the broom closet.
Fit into the smallest room.

Men's Kitchen [®]
by MATADOR.

■ **PICCOLO**



600 mm / 24"

676 mm / 26"

1.276 mm

- Width 1,276 mm, height 1,980 mm
- High wall cabinet with 3 adjustable shelves, door hinge left or right side
- Cupboard with gas strut (1x)
- Perforated panel (2x) for accessories
- Beech wood or stainless steel worktop (B677 x T500 x H40 mm)
- Drawer cabinet with 7 full extension drawers (5x H75, 2x H154 mm)
- Central lock
- Dark grey / light grey color
- Including hook assortment S
- Delivered without tools and accessories

■ **COMPACT**



600 mm / 24"

676 mm / 26"

676 mm / 26"

1.956 mm

- Width 1,956 mm, height 1,980 mm
- High wall cabinet with 3 adjustable shelves, door hinge left or right side
- Cupboard with gas strut (2x)
- Perforated panel (4x) for accessories
- Beech wood or stainless steel worktop (B1,354 x T500 x H40 mm)
- Drawer cabinet with 7 full extension drawers (5x H75, 2x H154 mm)
- Closet with adjustable shelf
- Central lock
- Dark grey / light grey color
- Including hook assortment M
- Delivered without tools and accessories

ART. CODE	Worktop		
8152 0001	Beech	152	1,295.- €
8152 0002	Stainless Steel	kg	

ART. CODE	Worktop		
8152 0011	Beech	213	1,995.- €
8152 0012	Stainless Steel	kg	

Plenty of space to work. With 10 drawers.
Including 2,215 mm worktop in one piece.

■ MEDIUM

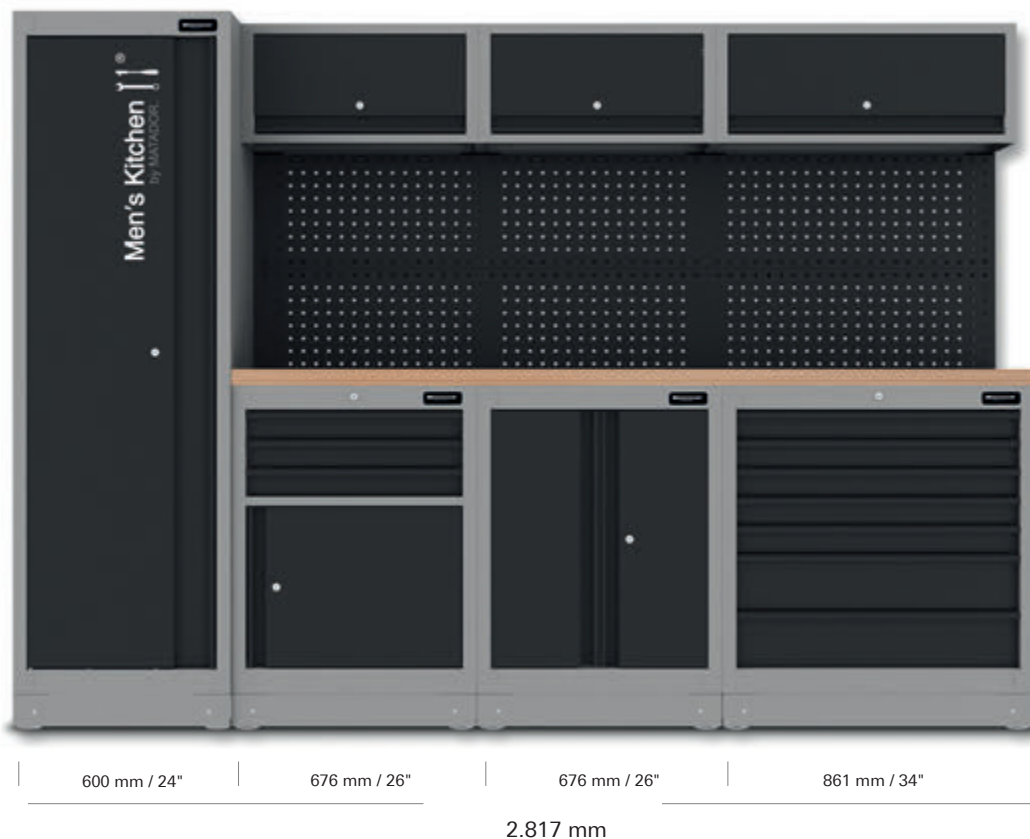

- Width 2,817 mm, height 1,980 mm
- High wall cabinet with 3 adjustable shelves, door hinge left or right side
- Cupboard with gas strut (3x)
- Perforated panel (6x) for accessories
- Beech wood or stainless steel worktop (B2,215 x T500 x H40 mm)
- Drawer cabinet with 3 full extension drawers and 1 door
- Closet with adjustable shelf
- Drawer cabinet L with 7 full extension drawers (5x H75, 2x H154 mm)
- Central lock
- Dark grey / light grey color
- Including hook assortment L
- Delivered without tools and accessories

ART. CODE	Worktop	⚖️	
8152 0021	Beech	310	2,795.- €
8152 0022	Stainless Steel	kg	

With mobile tool trolley.
Work where you want.

Men's Kitchen [®]
by MATADOR.

■ **MOBILO**

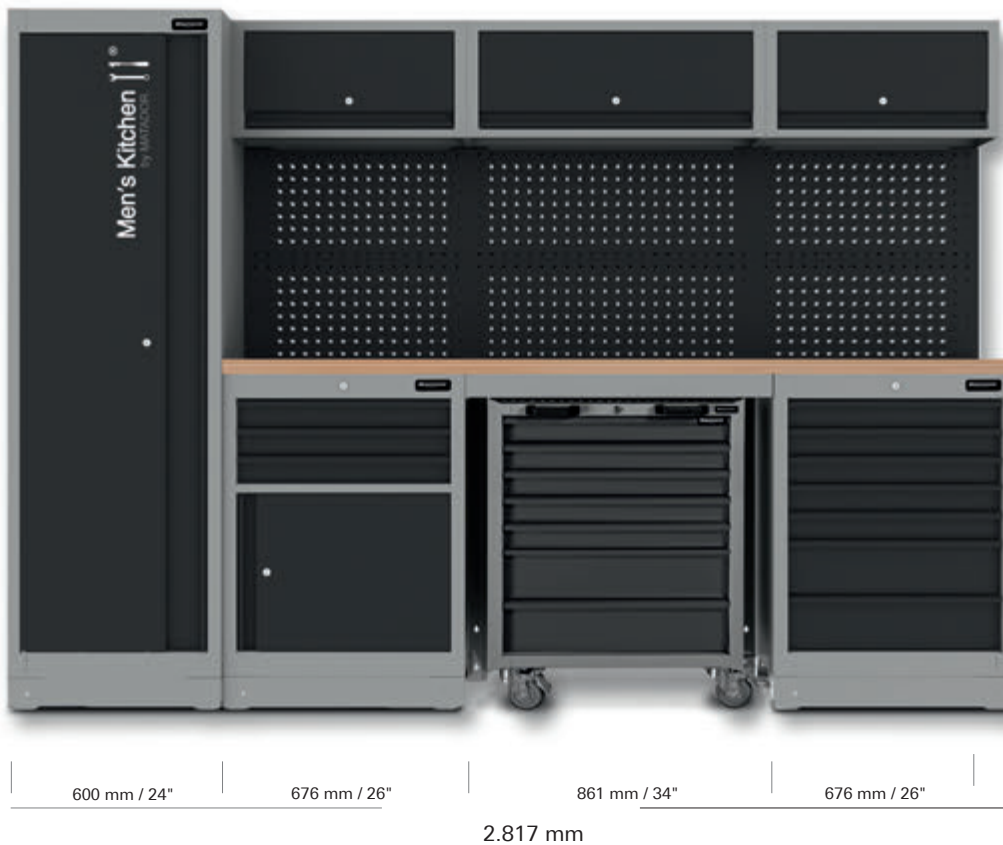

- Width 2,817 mm, height 1,980 mm
- High wall cabinet with 3 adjustable shelves, door hinge left or right side
- Cupboard with gas strut (3x)
- Perforated panel (6x) for accessories
- Beech wood or stainless steel worktop (B2,215 x T500 x H40 mm)
- Drawer cabinet with 3 full extension drawers and 1 door
- Service trolley with 7 drawers (5x H75, 2x H154 mm)
- Drawer cabinet with 7 full extension drawers
- Central lock
- Dark grey / light grey color
- Including hook assortment L
- Delivered without tools and accessories

ART. CODE	Worktop		
8152 0031	Beech	315	2,795.- €
8152 0032	Stainless Steel	kg	

A real statement.
For ambitious tool connoisseurs.

Men's Kitchen 
by MATADOR.

■ **GRANDE**

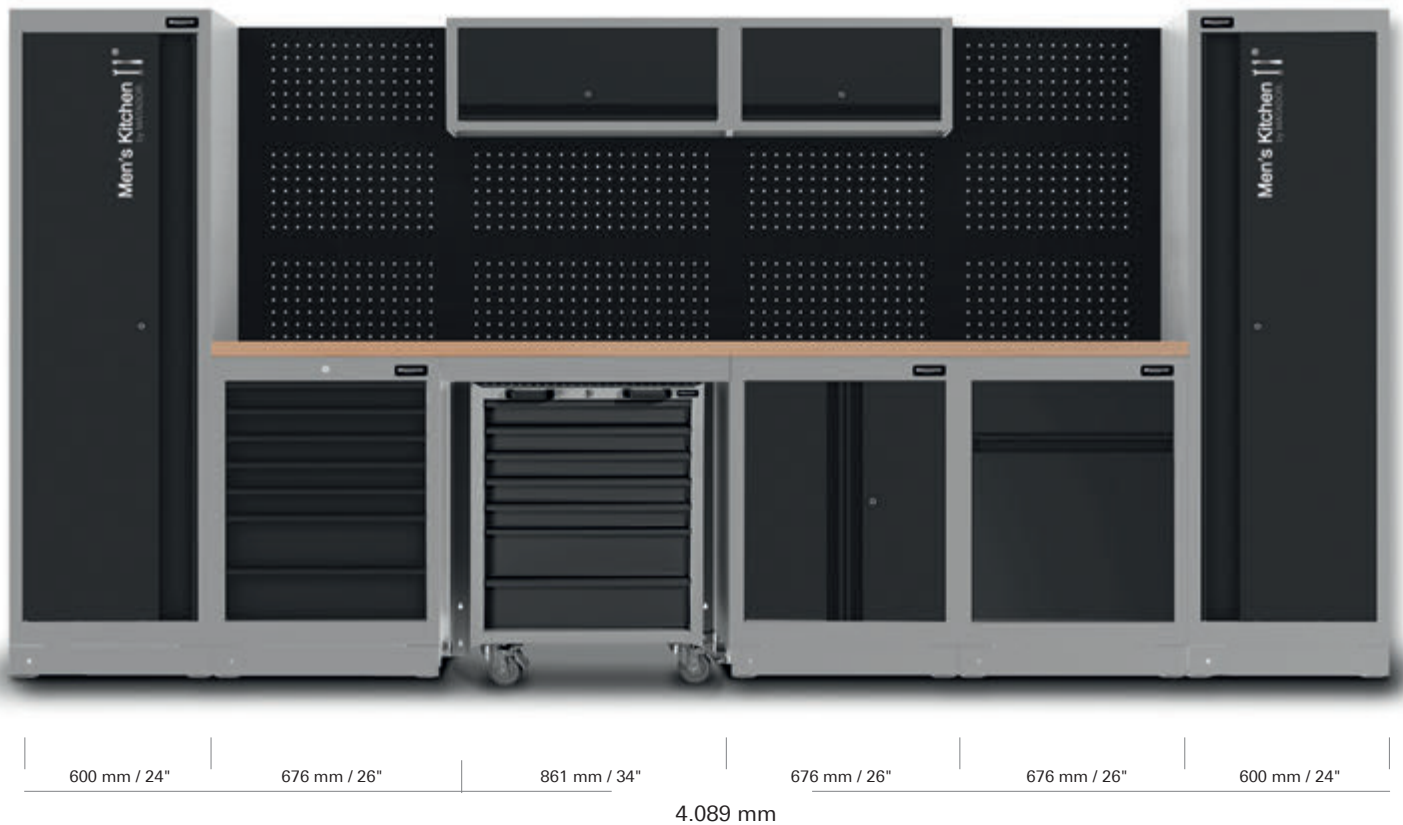

- Width 4,089 mm, height 1,980 mm
- High wall cabinet with 3 adjustable shelves, door hinge left or right side (2x)
- Cupboard with gas strut (2x)
- Perforated panel (10x) for accessories
- Beech wood or stainless steel worktop (1x B2,215 x T500 x H40 + 1x B676 x T500 x H40 mm)
- Drawer cabinet with 7 full extension drawers
- Service trolley with 7 drawers (5x H75, 2x H154 mm)
- Closet with adjustable shelf
- Recycle bin cabinet
- Central lock
- Dark grey / light grey color
- Including hook assortment L
- Delivered without tools and accessories

ART. CODE	Worktop		
8152 0051	Beech	405	3,695.- €
8152 0052	Stainless Steel	kg	

Single Parts.

Numerous variations.

■ Drawer Cabinet 7 drawers



- 7 full extension drawers (5x H 75, 2x 154)
- Ball-bearing slides
- 676 x 960 x 500 (W x H x D mm)

ART. CODE
8152 2601

469.- €

■ Drawer Cabinet 3 drawers, 1 door



- 3 full extension drawers (3x H 75)
- 1 door
- Ball-bearing slides
- 676 x 960 x 500 (W x H x D mm)

ART. CODE
8152 2602

399.- €

■ Closet 2 doors



- 2 doors
- 1 adjustable shelf
- 676 x 960 x 500 (W x H x D mm)

ART. CODE
8152 2603

329.- €



■ Wall Cabinet

- 1 door
- 3 adjustable shelves
- Optional wardrobe rail
- 600 x 1,980 x 526 (W x H x D mm)

ART. CODE
8152 2401

499.- €

■ Drawer Cabinet L 7 drawers



- 7 full extension drawers (5x H 75, 2x 154)
- Ball-bearing slides
- 861 x 960 x 500 (W x H x D mm)

ART. CODE
8152 3401

589.- €

■ Drawer Cabinet L 3 drawers



- 2 big full extension drawers, ideal for tool cases (1x H 300, 1x H 445)
- Ball-bearing slides
- 861 x 960 x 500 (W x H x D mm)

ART. CODE
8152 3406

489.- €

■ Multi Function Cabinet L



- Left side: retractable waste compartment with plastic container
- Right side: empty compartment for paper rolls
- Right bottom side: big drawer for cases (H 395)
- 861 x 960 x 500 (W x H x D mm)

ART. CODE
8152 3404

499.- €

■ Recycle Bin Cabinet

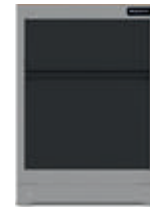

- Self-closing flap
- Retractable bottom compartment incl. 2 plastic containers (H 525)
- 676 x 960 x 500 (W x H x D mm)

ART. CODE
8152 2604

399.- €

■ Service Trolley 7 drawers



- Fits under the worktop
- 7 full extension drawers (5x H 75, 2x H 154)
- Ball-bearing slides
- 676 x 963 x 459 (W x H x D mm)

ART. CODE
8152 2620

499.- €

■ Cupboards



- 1 door
- With gas strut
- 676 x 338 x 300 (W x H x D mm)

ART. CODE
8152 2605

129.- €



- 1 door L
- With gas strut
- 861 x 338 x 300 (W x H x D mm)

ART. CODE
8152 3405

139.- €

■ Perforated Panels



- With square perforation
- Set incl. 2 pcs
- 676 x 338 x 20 (W x H x D mm)

ART. CODE
8152 2607

49.- €



- With square perforation
- Set incl. 2 pcs
- 861 x 338 x 20 (W x H x D mm)

ART. CODE
8152 3407

59.- €

All cabinets and closets without worktop.

Cabinets made of welded steel tubes and sectional steel, pre-assembled.

Single Parts.

Numerous variations.

Worktops Beech Wood Multiplex



ART. CODE	L x B x H mm	
8152 0090	677 x 500 x 40	179.- €
8152 0091	861 x 500 x 40	249.- €
8152 0092	1354 x 500 x 40	349.- €
8152 0093	1722 x 500 x 40	449.- €
8152 0094	2215 x 500 x 40	599.- €

Worktops Stainless Steel



ART. CODE	L x B x H mm	
8152 1090	677 x 500 x 40	199.- €
8152 1091	861 x 500 x 40	229.- €
8152 1092	1354 x 500 x 40	349.- €
8152 1093	1722 x 500 x 40	399.- €
8152 1094	2215 x 500 x 40	499.- €

Support Brackets L/R

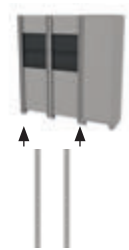

- Left / right
- Needed for panels and cupboards
- To be screwed to the cabinets
- (W x H x T mm)

ART. CODE
8152 0098

49.- €

Middle Bracket

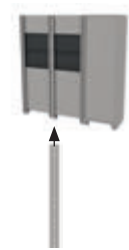

- Needed for panels and cupboards
- To be screwed to the cabinets
- (W x H x T mm)

ART. CODE
8152 0099

39.- €

Bottom Side Panels



For drawer cabinet (L 472 mm)

ART. CODE
8152 0096 **6.95 €**

For wall cabinet (L 500 mm)

ART. CODE
8152 0097 **6.95 €**

Accessories

Adjustable Shelf for wall cabinet

ART. CODE
8152 2402 **19.95 €**

Wardrobe Rail for wall cabinet

ART. CODE
8152 2403 **4.95 €**

Adjustable Shelf 600 mm / 26"

ART. CODE
8152 2690 **19.95 €**

Adjustable Shelf 800 mm / 34"

ART. CODE
8152 3490 **24.95 €**



Compatible drawer raster.

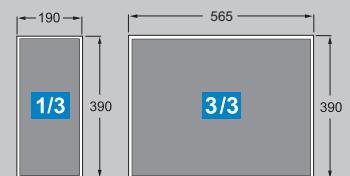

Accessories.

We put tools in order.

■ Single Hooks



ART. CODE	mm	Price
8141 0100	50	1.65 €
8141 0101	150	2.35 €

■ Double Hooks



ART. CODE	mm	Price
8141 0110	50	2.75 €
8141 0111	150	2.95 €

■ Pliers Holder



ART. CODE	mm	Price
8141 0115	55x70	2.95 €

■ Round Holder



ART. CODE	mm	Price
8141 0120	65x25	2.95 €

■ Small Parts Tray



ART. CODE	mm	Price
8141 0130	150x55	9.95 €

■ Wrench Holder

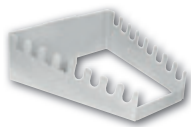

ART. CODE	Price
8141 0140	7.95 €

■ Screwdrivers Holder



ART. CODE	Price
8141 0150	7.95 €

■ Drill Holder



ART. CODE	Price
8141 0160	7.95 €

■ Socket Holder



ART. CODE	Price
8141 0180	12.95 €

■ Cable Holder



ART. CODE	Price
8141 0190	7.95 €

■ Paper Roll Holder



ART. CODE	Price
8141 0200	30.95 €

■ Waste Bin



ART. CODE	Price
8141 0210	31.95 €

■ Tin Holder



ART. CODE	mm	Price
8141 0220	300x70	24.95 €

■ Cable Reel with hanger for perforated panel



ART. CODE	mm	Price
8141 0001	10	64.95 €

■ Hook Assortment S 10 pcs



- 5 single hooks 50 mm
- 5 double hooks 50 mm

ART. CODE	Price
8141 0250	24.95 €

■ Hook Assortment M 20 pcs



- 10 single hooks 50 mm
- 10 double hooks 50 mm

ART. CODE	Price
8141 0251	48.95 €

■ Hook Assortment L 30 pcs



- 10 single hooks
- 10 double hooks
- 6 pliers holders
- 3 round holders
- 1 screwdrivers holder

ART. CODE	Price
8141 0252	79.95 €

■ Hook Assortment XL 40 pcs



- 15 single hooks 50 mm
- 15 double hooks 50 mm
- 6 pliers holders
- 3 round holders
- 1 screwdrivers holder

ART. CODE	Price
8141 0253	99.95 €



All MATADOR tool trolleys and perforated panels have a standardized 10x10 perforation raster:

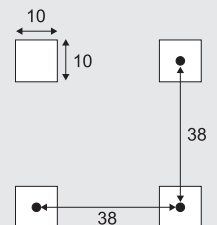

Hooks, holders and accessories allow a space-saving and well-organized storage of tools, small parts and work material.

Tool trolley ALLROUND.

The mobile workshop.



Outside dimensions:
370 (h) x 485 (a) x 190 (b)

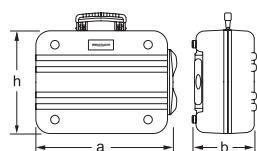

SMARTY BOX

Incl. SMARTY-Box.

Content:

	0190	8 - 32 mm
	0442	1,5 - 10 mm L
	0444	T10 - T50
	3K 0500	165 mm (6.1/2")
	3K 0530	165 mm (6.1/2")
	3K 0585	170 mm (6.3/4")
	0556	240 mm (9.1/2")
	0588	250 mm (10")
	0591	300 mm (12")
	0616	4 x 100 mm
	0615	5,0 x 100 mm, 6,5 x 150 mm, 8,0 x 175 mm, 10,0 x 250 mm
	0655	PH 1 x 80 mm, PH 2 x 100 mm PH 3 x 150 mm
	0657	P2 1 x 80 mm, P2 3 x 150 mm
	0635	0,5 x 3,0 x 65 mm
	0671	10 - 13 x 230 mm
	0700	35 mm
	0705	300 g, 500 g
	0718	∅ 2 - 3 - 4 - 5 - 6 - 8 mm
	0719	3 - 4 - 125 - 150 mm



	0786	440 mm
	0798	5 m
	0743	140 mm
	0745	250 mm
	0826	180 mm
	0762	Drill assortment HSS-R
	0775	200 mm 5-tlg.
	0782	290 x 40 mm
	0784	1.000 g
	0798	300 x 30 x 1,0 mm
	0799	140 mm
	0840	250 mm
	0843	5-tlg.
	4061	12,5 mm 1/2" 36°
	4064	12,5 mm 1/2"
	4065	125 - 250 mm
	4068	12,5 mm 1/2"
	4075	10 - 11 - 12 - 13 - 14 - 15 16 - 17 - 18 - 19 - 22 - 24 27 - 30 - 32 mm
	2155	SMARTY-Box, 47 pcs

Stay mobile with the MATADOR premium trolley ALLROUND including 185-pc tool set.

Extremely robust, double-walled tool case with telescopic handle and smooth-running wheels. Comprehensive tool set „Best of MATADOR“.



Snap-lock telescopic handle.



Large, smooth-running wheels.



3KsoftGRIP
Innovative pliers set with 3C handles and many additional functions.



Including SMARTY-Box, our practical universal socket box.



Bottom can be divided by variable inserts.

ART. CODE **8132 0185** ¹⁸⁵ **899.- €**



Innovations and hot deals.
2018 EN. 



Stay tuned.



More MATADOR products?
Browse or download our
450-page main catalogue.



www.matador.de

MATADOR GmbH & Co. KG

Morsbachtalstr. 17
42855 Remscheid
Germany

Tel. +49 2191 97 43 - 0
Fax +49 2191 97 43 - 44

sales@matador.de

Your dealer:

Delivery without decoration. Technical specifications subject to modifications.
No liability for printing errors. Please ask your local dealer.
Valid until 28 February 2019.

Be a MATADOR.

H I T