

# HIT

Innovations and hot deals.  
2021 EN. 



Premium hand tools and more since 1900.



Be a MATADOR.



MATADOR is one of the **pioneers in the tool industry.**

Since 1900 we have been producing **quality hand tools** „around the screw“ in Remscheid, the German capital of the tool industry. Our core competences are spanners, sockets, torque and pneumatic tools as well as modules for workshops. **For all kinds of screws from 3.2 to 230 mm.** 4,500 catalogue articles. Tried and tested a million times. Export in >70 countries. For ambitious users in industry, trade and the automotive industry. MATADOR is an **accredited supplier of all major OEMs** like Audi, Bosch, Ford, MAN, Mercedes-Benz, Volkswagen, Volvo, etc.





MATADOR is **the opposite of mainstream.**

We stand for upmarket premium tools. Reliable, design-focused, efficient. Intelligent tightening tools made for decision makers, fighters and **everyday heroes.** For real MATADORS.

For people who know and express what they want. People **who are inside the arena**, not in the stands. Who know **the difference between tools and toys.** Who do not seek excuses and are true to themselves. Past and present. For down-to-earth, straightforward and assertive individuals with life experience and stories to tell. Who overcome adversity, manage a healthy work-life balance and **believe in themselves.**

Welcome to the arena.

**Be a MATADOR.**





# It takes something more to make a really good ratchet.

More teeth. More power. More grip. More applications. More design.



## 25%

reduced angle (only 4°) compared to standard fine-toothed ratchets thanks to an **innovative 90-teeth technique**. Still ready for working even when it gets really tight.

## 50%

more torque than requested in the DIN standard (e.g. 12.5 mm (1/2") > 750 N·m). Still loosens screws when others have long given up.



Extremely robust square shank made of **Chrome Vanadium steel** for high resilience in every situation.

Recessed, **flat lever** for quick change of direction.

**Push-button lock** for a safe connection between ratchet and socket.

# 4°

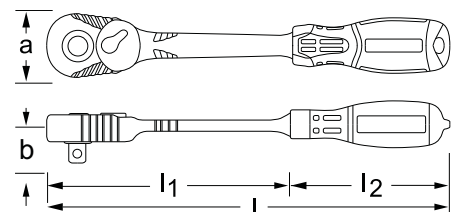



**Extremely fine toothed, extremely strong, extremely ergonomic.**

**Light grey, soft zone made of TPE plastic**, especially anti-slip, for good grip and a comfortable support to the fingers.

**Medium grey, nubby zone** made of TPE plastic, large area for non-slip grip and transmission of high powers.

**Black, hard zone** made of special plastic for quick gripping without sticking.



Ergonomic and comfortable thumb rest.

**max.**

ergonomics thanks to multi-component handle, better than standard 1- or 2-component handles. Optimally adapted, spherical shape.



Practical **hanging loop** to secure the ratchet during construction work or to hang on a tools panel.

■ Ratchet

**1/4**



°	l mm	l1 mm	l2 mm	a mm	b mm	g
4	125	70	55	23,5	24,7	112

ART. CODE  
2061 0090

■ Ratchet

**3/8**



°	l mm	l1 mm	l2 mm	a mm	b mm	g
4	200	120	80	29,1	32,8	234

ART. CODE  
3061 0090

■ Ratchet

**1/2**



°	l mm	l1 mm	l2 mm	a mm	b mm	g
4	275	165	110	37,7	42,2	539

ART. CODE  
4061 0090



**Smart toolboxes.**  
Intelligent solutions for mobile use.



Our smallest.  
Compact in pocket size.



■ L-BOXX®-Mini, empty

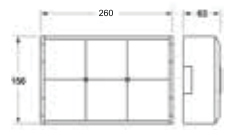

ART. CODE  
8145 0020



Stackable and can be clicked onto each other for easy transportation.





The new smartyBOX.  
The world's smallest workshop.

■ **i-BOXX<sup>®</sup>, empty**

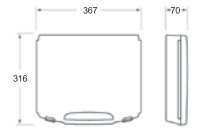

ART. CODE  
**8145 0030**



Perfect order  
at every location.

Space for small parts.

■ **L-BOXX<sup>®</sup>118, empty**

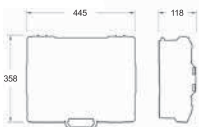

ART. CODE  
**8145 0035**

■ **L-BOXX<sup>®</sup>152, empty**

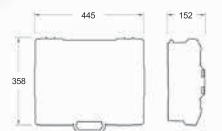

ART. CODE  
**8145 0040**



## Everything at a glance.

Tool sets systems.

Intelligent tool with numerous additional functions in a versatile transport box - that is the concept of MATADOR smartyBOX.

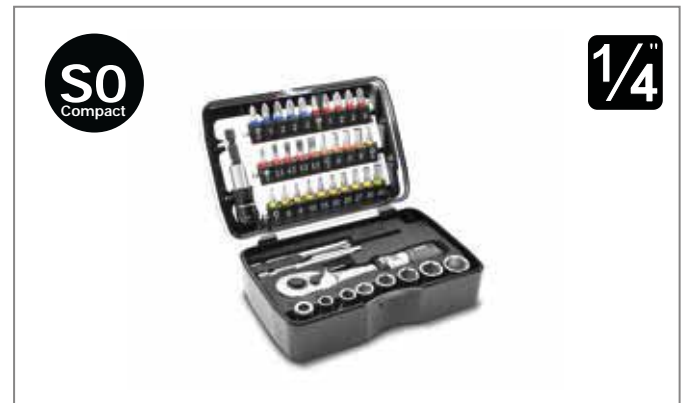

The 47-piece S0 Compact fits into any glove box or under the motorcycle seat with its handy size.



The 52-piece S0 is our budget-friendly solution for entering the world of smartyBOXes.

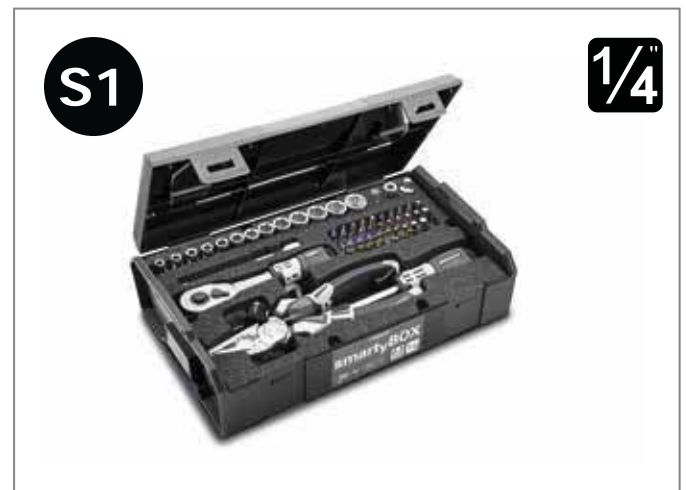

The 61-piece S1 leaves nothing to be desired to make just a little repair. Including bayonet stub and premium combination pliers.



The 26-piece S2 is the perfect compact box for all screw connections from 6 - 22 mm with adjustable ratchet spanner for counter-ringing.



The 12-piece S3 can be used as an extra narrow ratchet wrench thanks to the combination ratchet spanners with switch lever and supplied ratchet adaptors.





The 75-piece S4 is the complete set in 1/4" and 1/2" for all screw connections from 4 - 32 mm.



The 29-piece S5 is the complete set in 1/2" for all screw connections from 8 - 32 mm.



The 80-piece L1 is the 1/2" socket set with removable S1 smartyBOX in 1/4" for all screw connections from 4 - 32 mm.



The 42-piece L2 is the all-round tool set with everything an ambitious craftsman needs.



**The smartyBOX.**  
Really smart.



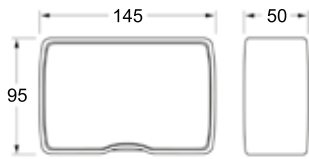

Compact in size:  
B 145 x T 95 x H 50 mm.

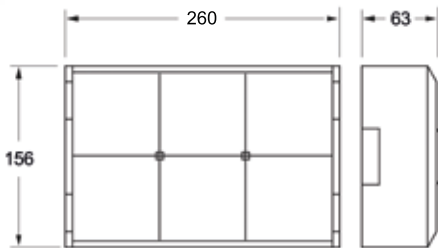

Compact in size:  
W 260 x D 156 x H 63 mm.



Stackable and can be clicked onto each other for easy transportation.

■ **smartyBOX S0 c,**  
47 pcs



The **S0 Compact** with its **handy size** of just 145 x 95 mm fits in any drawer, even in your desk or under the motorcycle seat.

Including the new MATADOR **Z90L** 1/4" reversible ratchet with **90 teeth** for the smallest gaps drives either 30 standard bits of high-alloy S2 material (25 mm), 6 extra-long screwdriver blades (75 mm) **with color guide system** for faster identification or sockets with **double smart drive profile**.

Everything is fit securely into **MFS foam inlays** and survives even the hardest fall.

Content:

- 2061 Reversible Ratchet **Z90L**
- 2065 Extension 50 mm
- 2075 6 - 7 - 8 - 9 - 10 - 11 - 13 mm
- 2084 Bit-Adapter F
- 7040 Drill Adapter for Bits
- 7026 Bits 3 - 3.5 - 4.5 - 5.5 - 6.5 x 25 mm  
Screwdriver-Bits long type: 4 - 6 x 75
- 7027 Bits PH 0 - PH 1 - PH 2 - PH 2 - PH 3 x 25 mm  
Screwdriver-Bits long type: PH 1 - PH 2 x 75
- 7027 Bits PZ 0 - PZ 1 - PZ 2 - PZ 2 - PZ 3 x 25 mm
- 7028 Bits 3 - 4 - 5 - 6 x 25 mm
- 7033 Bits T6 - T7 - T8 - T9 - T10 - T15 - T20 - T25  
T27 - T30 - T40 x 25 mm  
Screwdriver-Bits long type: T25 - T30 x 75

ART. CODE  
2155 0001



■ **smartyBOX S0,**  
52 pcs



Low budget **universal box** including the new MATADOR **Z90L** 1/4" reversible ratchet.

Comes with everything needed for screw tasks from 4 - 14 mm. With **innovative spinner handle** that can be used as a **multi-screwdriver** and extends a total length of 370 mm.

Content:

- 2061 Reversible Ratchet **Z90L**
- 2065 Extensions 50 - 100 mm
- 2073 Multi Component Spinner Handle
- 2075 4 - 4.5 - 5 - 5.5 - 6 - 7 - 8 - 9 - 10 - 11 - 12 - 13 - 14 mm
- 2084 Bit-Adapter F
- 2084 Bit-Adapter M
- 7040 Drill Adapter for Bits
- 7026 Bits 3 - 3.5 - 4.5 - 5.5 - 6.5 x 25 mm
- 7027 Bits PH 0 - PH 1 - PH 2 - PH 2 - PH 3 x 25 mm
- 7027 Bits PZ 0 - PZ 1 - PZ 2 - PZ 2 - PZ 3 x 25 mm
- 7028 Bits 3 - 4 - 5 - 6 x 25 mm
- 7033 Bits T6 - T7 - T8 - T9 - T10 - T15 - T20 - T25  
T27 - T30 - T40 x 25 mm
- 8191 Lanyard with snap hook for securing the reversible ratchet

ART. CODE  
8145 2110





■ **smartyBOX S1,**  
61 pcs

**S1**













**1/4"**



Ultra-handy **universal box** including the new MATADOR **Z90** 1/4" reversible ratchet.

The absolute full equipment for screw tasks from 4 - 14 mm, including **combination pliers with integrated ring spanner** for countering. With **innovative spinner handle** that can be used as a **multiscrewdriver** and extends to a total length of 420 mm.

Content:

-  **3K 0500** 3C Combination Pliers 160 mm
- 0500** Retaining Clip for Combination Pliers
-  **0.3 1/4 2061** Reversible Ratchet **Z90**
-  **0.3 1/4 2065** Extensions 50 - 100 mm
-  **0.3 1/4 2068** Universal Joint
-  **0.3 1/4 2073** Multi Component Spinner Handle
-  **0.3 1/4 2075** 4 - 4.5 - 5 - 5.5 - 6 - 7 - 8 - 9 - 10 - 11 - 12 - 13 - 14 mm
-  **0.3 1/4 2084** Bit-Adapter F
-  **0.3 1/4 2084** Bit-Adapter M
-  **7026** Bits 3 - 3.5 - 4.5 - 5.5 - 6.5 x 25 mm  
Screwdriver-Bits long type: 4 - 6 x 75
-  **7027** Bits PH 0 - PH 1 - PH 2 - PH 3 x 25 mm  
Screwdriver-Bits long type: PH 1 - PH 2 x 75
-  **7027** Bits PZ 0 - PZ 1 - PZ 2 - PZ 3 x 25 mm
-  **7028** Bits 3 - 4 - 5 - 6 x 25 mm
-  **7033** Bits T6 - T7 - T8 - T9 - T10 - T15 T20 - T25 - T27  
T30 - T40 x 25 mm  
Screwdriver-Bits long type: T25 - T30 x 75
- 8191** Lanyard with snap hook for securing the reversible ratchet

ART. CODE  
**8145 2115** 

■ **smartyBOX S2,**  
25 pcs

**S2**







**3/8"**



Compact socket set including the new MATADOR **Z90** 3/8" reversible ratchet.

**Covers 90 % of all screw tasks** with socket sizes from 6 - 22 mm. **8° swivelling extension bars** included for screw connections that are difficult to reach. With **adjustable wrench**, perfect for countering or screw tasks that require an open ended spanner (e.g. when bolts are in the way).

Content:

-  **0591** Adjustable Wrench 1-20 mm (8")
-  **10 3/8 3061** 3061 Reversible Ratchet **Z90**
-  **10 3/8 3065** Swivelling Extension Bars 75 - 125 mm
-  **10 3/8 3068** Universal Joint
-  **10 3/8 3075** 6 - 7 - 8 - 9 - 10 - 11 - 12 - 13 - 14 - 15 - 16 - 17 - 18 - 19 - 20 - 21 - 22 mm
-  **10 3/8 3084** Bit-Adapter F
-  **10 3/8 3085** Drill Adapter for Sockets
- 8191** Lanyard with snap hook for securing the reversible ratchet

ART. CODE  
**8145 3115** 

■ **smartyBOX S3,**  
12 pcs

**S3**





**72**



**Innovative supplement** with combination ratchet spanners and ratchet adapters.

Combination ratchet spanners **with lever** for quick change of direction. With slightly angled ring side. Includes the most important **spanner sizes from 7 - 19 mm** and **4 additional ratchet adapters** for using the ratchet spanners as a fully usable ratchet for sockets.

Content:

-  **0189** 7 - 8 - 10 - 12 - 13 - 15 - 17 - 19 mm
-  **0186** Bit Adapter for Combination Ratchet Spanners SW 10
-  **0186** **0.3 1/4** Ratchet Adapter for Combination Ratchet Spanners SW 10
-  **0186** **10 3/8** Ratchet Adapter for Combination Ratchet Spanners SW 13
-  **0186** **12 1/2** Ratchet Adapter for Combination Ratchet Spanners SW 19

ART. CODE  
**8145 0189** 

## The smartyBOX S4.

The next generation's socket sets.



Sockets with double Smart Drive profile and super chrome coating.



Quality ratchet with 90 teeth and only 4° swivel angle for up to 750 N · m.

### ■ smartyBOX S4, 29 pcs

**S4**



**1/2"**

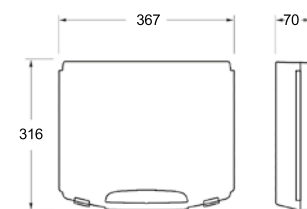

The **MATADOR i-Boxx 72** protects the socket set from splash water and ensures **maximum order**. It can be **integrated into the MATADOR system**. The sturdy stacking box has a **load capacity of up to 5 kg** and gives a perfect overview thanks to the **transparent closure lid** and inscribable handle. External dimensions (W x D x H): 367 x 316 x 72 mm.



#### Content

		4061	Reversible Ratchet <b>Z90</b>	
		4064	Sliding Handle	
			4065	Extensions 125 mm
			4068	Universal Joint
			4075	8 - 9 - 10 - 11 - 12 - 13 - 14 - 15 - 16 - 17 - 18 19 - 20 - 21 - 22 - 23 - 24 - 26 - 27 - 28 - 30 32 mm
			4081	16 - 18 - 20,8 mm

ART. CODE

8145 4114





# The smartyBOX S5.

The next generation's socket sets.



MATADOR reversible ratchet for the smallest gaps.



Standard bits made of high-alloy S2 material with color guide system.



Patented spinner handle with bayonet mount for bit and square drive.

## smartyBOX S5, 75 pcs

**S5**

**1/4" 1/2"**



### Content

		2061 Reversible Ratchet <b>Z800-</b>
		2064 Sliding Handle
		2065 Extensions 50 - 100 mm
		2068 Universal Joint
		2073 Multi Component Spinner Handle
		2075 4 - 4.5 - 5 - 5.5 - 6 - 7 - 8 - 9 - 10 - 11 - 12 13 - 14 mm
		2084  Bit-Adapter F
		2085  Drill Adapter for Bits
		7026 Bits 3 - 3.5 - 4.5 - 5.5 - 6.5 x 25 mm
		7027 Bits PH 0 - PH 1 - PH 2 - PH 2 - PH 3 x 25 mm
		7027 Bits PZ 0 - PZ 1 - PZ 2 - PZ 2 - PZ 3 x 25 mm
		7028 Bits 3 - 4 - 5 - 6 x 25 mm
		7033 Bits T6 - T7 - T8 - T9 - T10 - T15 - T20 - T25 T27 - T30 - T40 x 25 mm
		4061 Reversible Ratchet <b>Z800-</b>
		4064 Sliding Handle
		4065 Extensions 125 mm
		4068 Universal Joint
		4075 10 - 11 - 12 - 13 - 14 - 15 - 16 - 17 - 18 - 19 20 - 21 - 22 - 23 - 24 - 26 - 27 - 28 - 30 - 32 mm

ART. CODE  
8145 4118



# The smartyBOX L1.

Multifunctional. Versatile. Flexible.

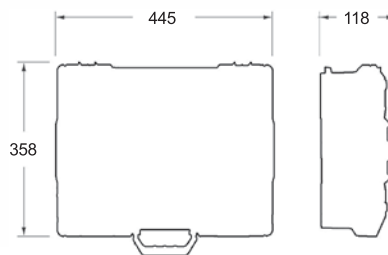

Including removable smartyBOX S1 with folding handle.



Stackable by simply clicking and separating the boxes.

## smartyBOX L1, 80 pcs

L1

1/4" 1/2"



### Content:

	<b>3K</b>	<b>0500</b>	3C Combination Pliers 160 mm
		<b>0500</b>	Retaining Clip for Combination Pliers
	<b>6.3</b>	<b>1/4</b>	<b>2061</b> Reversible Ratchet <b>Z90</b>
	<b>6.3</b>	<b>1/4</b>	<b>2065</b> Extensions 50 - 100 mm
	<b>6.3</b>	<b>1/4</b>	<b>2068</b> Universal Joint
	<b>6.3</b>	<b>1/4</b>	<b>2073</b> Multi Component Spinner Handle
	<b>6.3</b>	<b>1/4</b>	<b>2075</b> 4 - 4.5 - 5 - 5.5 - 6 - 7 - 8 - 9 - 10 - 11 - 12 - 13 - 14 mm
	<b>6.3</b>	<b>1/4</b>	<b>2084</b> Bit-Adapter F
	<b>6.3</b>	<b>1/4</b>	<b>2084</b> Bit-Adapter M
	<b>6.3</b>	<b>1/4</b>	<b>7040</b> Drill Adapter for Bits
	<b>6.3</b>	<b>1/4</b>	<b>7026</b> Bits 3 - 3.5 - 4.5 - 5.5 - 6.5 x 25 mm
	<b>6.3</b>	<b>1/4</b>	<b>7027</b> Bits PH 0 - PH 1 - PH 2 - PH 3 x 25 mm
	<b>6.3</b>	<b>1/4</b>	<b>7027</b> Bits PZ 0 - PZ 1 - PZ 2 - PZ 2 - PZ 3 x 25 mm
	<b>6.3</b>	<b>1/4</b>	<b>7028</b> Bits 3 - 4 - 5 - 6 x 25 mm
	<b>6.3</b>	<b>1/4</b>	<b>7033</b> Bits T6 - T7 - T8 - T9 - T10 - T15 - T20 - T25 - T27 - T30 - T40 x 25 mm
	<b>12.5</b>	<b>1/2</b>	<b>4061</b> Reversible Ratchet <b>Z90</b>
	<b>12.5</b>	<b>1/2</b>	<b>4065</b> Extensions 125 mm
	<b>12.5</b>	<b>1/2</b>	<b>4068</b> Universal Joint
	<b>12.5</b>	<b>1/2</b>	<b>4075</b> 8 - 9 - 10 - 12 - 13 - 14 - 15 - 16 - 17 - 18 - 19 - 20 - 21 - 22 - 24 - 26 - 27 - 30 - 32 mm
	<b>12.5</b>	<b>1/2</b>	<b>4081</b> 16 - 18 - 20,8 mm
		<b>8191</b>	Lanyard with snap hook for securing the reversible ratchet

ART. CODE  
**8145 4150**





# The smartyBOX L2.

The allround set for professionals.

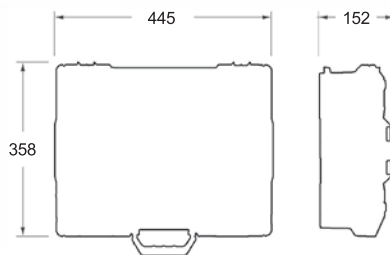

Tool compartment in the lid with even more premium tools.

## ■ smartyBOX L2, 42 pcs

**L2**



### Content:

		<b>0185</b>	8 - 10 - 11 - 13 - 14 - 17 - 19 - 22 mm
		<b>0440</b>	1.5 - 10 mm
		<b>0443</b>	T10 - T50
		<b>3K 0500</b>	180 mm (7")
		<b>3K 0532</b>	160 mm (6.1/4")
		<b>0556</b>	240 mm (9.1/2")
		<b>0615</b>	0.6 x 4.0 x 75, 0.8 x 5.0 x 100 mm, 1.0 x 5.5 x 125, 1.2 x 6.5 x 150 mm
		<b>0655</b>	PH1 x 80 mm, PH2 x 100 mm
		<b>0635</b>	0.5 x 3.0 x 65 mm
		<b>0664</b>	1.5 - 3.0 - PH 00 - PH 0
		<b>0705</b>	500g
		<b>0714</b>	200 mm
		<b>0787</b>	250 mm
		<b>0825</b>	200 mm
		<b>0797</b>	2 m

ART. CODE  
8145 4145



# Tool trolley **RATIO**.

One for everything. 7 or 8 drawers. Spacious, solid and loadable.



Our topseller **RATIO** now **with 7 or 8 drawers** with highly resistant powder coating (**black**, RAL 9005), drawer handles made of aluminium.

**Comfortable working height** (1,030 mm), **durable ABS worktop** with several compartments for small parts and holders for tins. Ergonomic handle for convenient pushing, pulling and turning even when fully loaded. **Rounded edges** and **integrated corner damage protection**. Both side panels with **square perforation** for assembly of accessories. Ball-bearing castors with high loading capacity (500 kg in total).

Drawers with **3-level locking system**: central locking, single-locked drawers, mechanical interlock („one at-a-time“ locking system). **Fully extendable drawers** (real 100%) with ball-bearing high performance slides. Including **pictogram labels** for individual drawer labelling and quick orientation.



Full extension drawers (100%), loading capacity up to 40 kg per drawer.



Durable ABS worktop with several compartments for small parts.



Individual aluminium name tag on request.



With 7 or 8 drawers.

## ■ Tool trolley **RATIO** with 7 drawers

Internal dimensions of drawers:

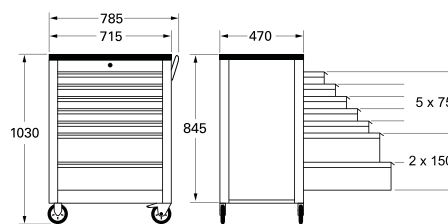
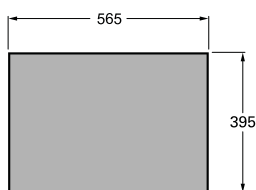

Tool trolley without tools and accessories.



ART. CODE  
**8163 0020** 

## ■ Tool trolley **RATIO** with 8 drawers

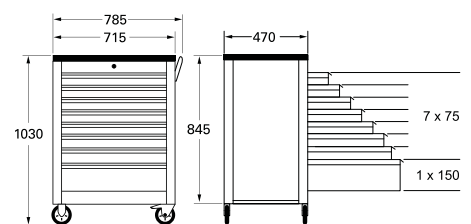

Tool trolley without tools and accessories.



ART. CODE  
**8163 0030** 

For more tool trolleys please refer to our 450-page main catalogue.



■ Tool Assortment smartyCAR, 150 pcs

6,3 <sup>1</sup>/<sub>4</sub> 12,5 <sup>1</sup>/<sub>2</sub>



**TOPSELLER**

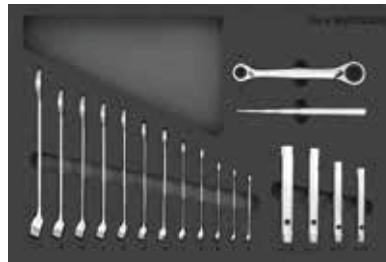

8164 5185



4in1 ring ratchet spanner with 120 teeth and only 3° angle.



8164 8145



Innovative Z 90 ratchets with 90 teeth for advanced tightening.



8164 2615



Removable smartyBOX S1.

The tool assortment smartyCAR is our special model with 150 tools „Best of MATADOR“. High quality tools for all kind of simple repair jobs and the entry level into the tool world of MATADOR.

It contains:

- Combination- and 4 in 1 ring ratchet spanner 6 - 22 mm
- Tubular box spanners with tommy bar
- Socket set with 6.3 mm (1/4") and 12.5 mm (1/2") drive, sockets 4 - 32 mm
- Screwdriver sockets for slotted, PH, hex and TORX® screws
- Pliers set with 3KsoftGrip handles
- Screwdriver set with 2-component handles for slotted and PH screws
- Mechanic's set with the most important striking tools
- Cutting and measuring tools



Including removable smartyBOX S1.



Hex keys with ballpoint head to use in awkward areas.



Assortment of practical helpers.



**With 150 selected tools.  
„For real MATADORS.“**

The detailed specification can be found at [www.matador.de](http://www.matador.de).



Tool assortment smartyCAR + Tool Trolley RATIO (7 drawers)

ART. CODE

8163 9150



■ Tool Assortment **UNIVERSAL**, 170 pcs



The tool assortment **UNIVERSAL** is the basic assortment with the most important tools for general repair jobs. High quality tools for home users and DIYers in the tool world of MATADOR.

It contains:

- Combination spanners and double open ended spanners 6 - 22 mm
- Nut Drivers with T-handle 8 - 10 - 13 mm
- Socket set with 6.3 mm (1/4") and 12.5 mm (1/2") drive, sockets 4 - 32 mm
- Screwdriver sockets for slotted, PH, hex and TORX® screws E4 - E11, T8 - T40
- Pliers set with **3KsoftGrip** handles
- Screwdriver set with 2-component handles for slotted and PH screws
- Mechanic's set with the most important striking tools
- 31-pc bitset and 25-pc drill assortment included

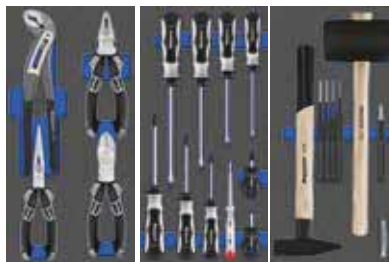
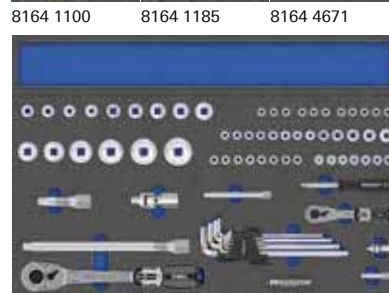
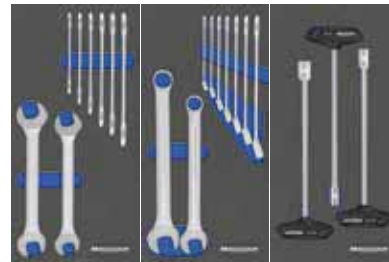

32-pcs torsion bitset included.

25-pcs twist drill assortment HSS-R included.



6.3 mm 1/4 12.5 mm 1/2

	0100	6 x 7 - 20 x 22 mm
	0185	6 - 8 - 10 - 11 - 13 14 - 17 - 19 - 22 mm
	0671	8 - 10 - 13 mm
	0442	1.5 - 10 mm
	2061	90°
	2065	50, 100 mm
	2068	
	2073	150 mm
	2075	4 - 14 mm
	2076	4 - 5.5 - 7 mm
	2077	PH 1 - 2 - 3
	2078	3 - 4 - 5 - 6 - 8 mm
	2090	E4 - E8, E10, E11
	2092	T8 - T40
	4061	90°
	4065	75, 250 mm
	4068	
	4075	10 - 32 mm
	0500	180 mm (7")
	0530	180 mm (7")
	0556	240 mm (10")
	0585	205 mm (8")
	0660	0.5 x 3 mm
	0615	0.8 x 5 - 1.0 x 5.5 1.2 x 6.5 mm
	0635	3 mm
	0655	PH 0 - PH 1 - PH 2
	0640	0.8 x 4 x 25 mm
	0641	PH 1
	0705	500 g
	0717	120 x 4 x 10 mm
	0718	3 - 4 - 5 - 6 mm
	0738	115 x 65 mm
	0762	Drillset HSS-R
	7052	Bitbox 32 pcs

**All you need.  
The expert's choice.**

The detailed specification can be found at [www.matador.de](http://www.matador.de).



Tool assortment **UNIVERSAL**  
+ Tool Trolley **RATIO** (7 drawers)

ART. CODE  
8163 9550





■ Tool Assortment **INDUSTRIAL**, 242 pcs

6.3 mm 1/4 12.5 mm 1/2

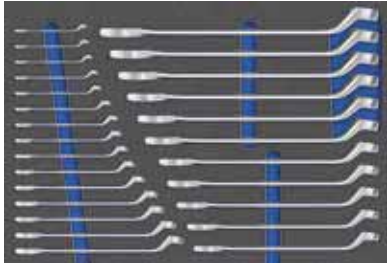

8164 3190

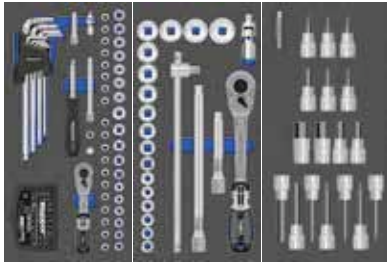

8164 1201

8164 1401

8164 4078

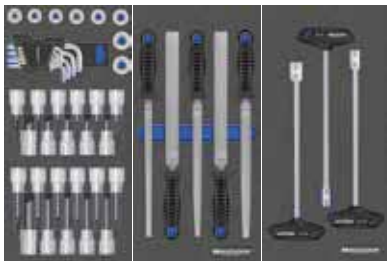

8164 4092

8164 1775

8164 4671



8164 1500

8164 1615

8164 1653



8164 1705



The detailed specification can be found at [www.matador.de](http://www.matador.de).



Tool assortment **INDUSTRIAL** + Tool Trolley **RATIO** (7 drawers)

ART. CODE  
8163 9570

	0190	6 - 32 mm
	0442	1,5 - 10 mm
	2061	60°
	2065	50, 100 mm
	2068	
	2073	150 mm
	2075	4 - 13 mm
	2076	4 - 5,5 - 7
	2077	PH 1 - 2 - 3
	2078	3 - 4 - 5 - 6 - 8
	2083	10 3/8
	2084	6,3 1/4
	2090	E4 - E8, E10, E11
	2092	T8 - T40
	7052	Bitbox 32 pcs
	4061	90°
	4064	300 mm
	4065	125, 250 mm
	4068	
	4075	10 - 32 mm
	4078	4 - 19 x 62 mm 4 - 12 x 100 mm
	0443	T10 - T50
	4090	E10 - E24
	4092	T20 - T80 x 62 mm T20 - T80 x 100 mm
	0775	200 mm
	0671	8 - 10 - 13 mm
	0500	180 mm (7")
	0530	180 mm (7")
	0556	240 mm (10")
	0585	205 mm (8")
	0660	0.5 x 3 mm
	0615	0.8 x 5 - 1.0 x 5.5 1.2 x 6.5 mm
	0635	3 mm
	0655	PH 0 - PH 1 - PH 2
	0640	0.8 x 4 x 25 mm
	0641	PH 1
	0652	1.0 x 5.5 - 1.2 x 8 2.0 x 12 mm
	0655	PH 1 - PH 2 - PH 3
	0700	ø 22, 35 mm
	0702	ø 40 mm / 750 g
	0705	500, 1000 g
	0714	125 - 175 - 200 mm
	0715	125 - 175 - 200 mm
	0716	3 - 6, 8, 10 mm
	0717	120 x 4 x 10 mm
	0718	ø 2 - 6, 8, 10 mm



The tool assortment **INDUSTRIAL** was designed by experts especially for industrial maintenance and assembly jobs. All tools for the experienced mechanic are included.

It contains:

- Combination spanners, deep offset 6 - 32 mm
- Socket set with 6.3 mm (1/4") and 12.5 mm (1/2") drive, sockets 4 - 32 mm
- Comprehensive assortment of screwdriver sockets for slotted, PH, hex and TORX® screws E4 - E11, T8 - T40
- Pliers set with **3KsoftGrip** handles
- Screwdriver set with 2-component handles for slotted, PH and TORX® screws and additional screwdriver set with striking cap
- Large mechanic's set with numerous striking tools
- and many more tools

■ Tool assortment **AUTOMOTIVE**, 182 pcs

6.3 mm 1/4 12.5 mm 1/2

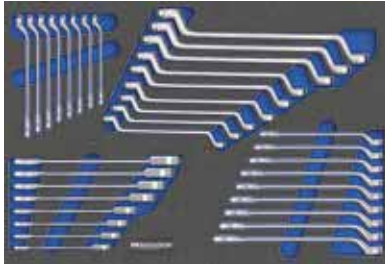

8164 1195

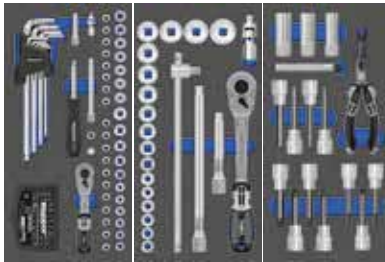

8164 1201

8164 1401

8164 1481



8164 1500

8164 1615

8164 1701



Tool assortment **AUTOMOTIVE**



Tool assortment **AUTOMOTIVE**  
+ Tool Trolley **RATIO** (7 drawers)

ART. CODE

8163 9560



		0183	8 - 10 - 11 - 13 16 - 17 - 18 - 19 mm
		0190	6 - 22 mm
		0200	6 x 7 - 21 x 23 mm
		0442	1.5 - 10 mm
		2061	90°
		2065	50, 100 mm
		2068	
		2073	150 mm
		2075	4 - 13 mm
		2076	4 - 5.5 - 7
		2077	PH 1 - 2 - 3
		2078	3 - 4 - 5 - 6 - 8
		2083	10 9/16
		2084	1/2 1/4
		2090	E4 - E8, E10, E11
		2092	T8 - T40
		7052	Bitbox 32 pcs
		4061	90°
		4064	300 mm
		4065	125, 250 mm
		4068	
		4075	10 - 32 mm
		0568	205 mm
		0760	13 x 0,05 - 1,00 mm
		4081	16 - 18 - 20,8 mm
		4078	5 - 6 - 7 - 8 x 100 mm
		4079	M6 - M8 - M10 M12 x 100 mm
		4092	T45 - T55 T70 x 100 mm
		0500	180 mm (7")
		0530	180 mm (7")
		0556	240 mm (10")
		0585	205 mm (8")
		0660	0,5 x 3 mm
		0615	0,8 x 5 - 1,0 x 5,5 1,2 x 6,5 mm
		0635	3 mm
		0655	PH 0 - PH 1 - PH 2
		0640	0,8 x 4 x 25 mm
		0641	PH 1
		0705	500 g
		0714	150 mm, 200 mm
		0717	120 x 4 x 10 mm
		0718	3 - 4 - 5 - 6 mm
		0798	3 m
		0827	18 mm
		0883	

■ Tool assortment **TRUCK**, 201 pcs



AUTOMOTIVE + add-on module **TRUCK**



8164 1708

		0100	24 x 27 - 25 x 28 30 x 32 mm
		0185	24 - 27 - 30 - 32 mm
		0200	24 x 27 - 25 x 28 30 x 32 mm
		0600	1,2 x 8 x 150 1,6 x 10 x 175 2,0 x 12 x 200 mm
		0650	PH 2 - PH 3 - PH 4
		0702	∅ 40 mm / 750 g
		0705	1000 g
		0754	500 mm

The tool assortment **TRUCK** contains the tool assortment **AUTOMOTIVE** and additionally a **19-pc module with basic tools for the repair of commercial vehicles**, e.g. spanners up to 32 mm and classical wooden screwdrivers with striking cap.

The detailed specification can be found at [www.matador.de](http://www.matador.de).



Tool assortment **TRUCK**  
+ Tool Trolley **RATIO** (7 drawers)

ART. CODE

8163 9561



**Selected tool assortments for automotive repair.**



■ Tool Assortment **AUTOMOTIVE PRO**, 297 pcs

6.3 mm 1/4 10 mm 3/8 12.5 mm 1/2

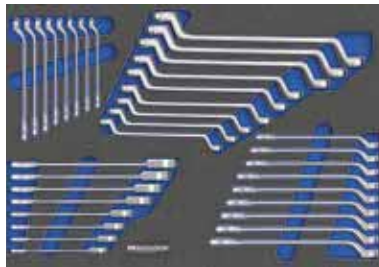

8164 1195

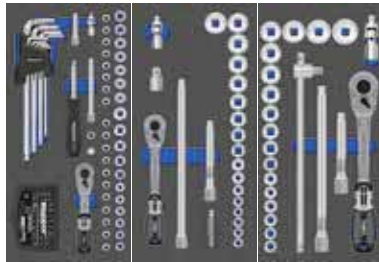

8164 1201 8164 1301 8164 1401

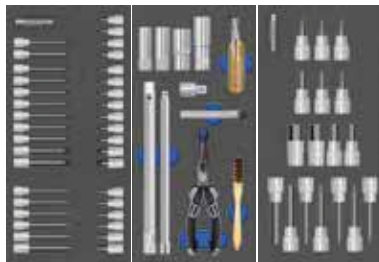

8164 3078 8164 3081 8164 4078

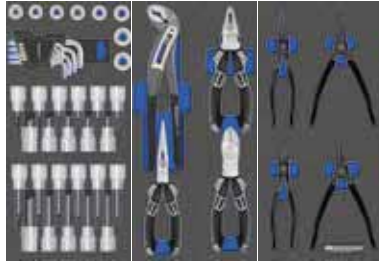

8164 4092 8164 1500 8164 1504

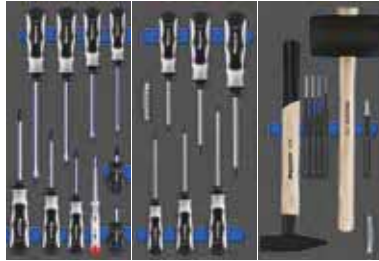

8164 1615 8164 1620 8164 1707

		0183	8 - 10 - 11 - 13 16 - 17 - 18 - 19 mm
		0190	6 - 22 mm
		0200	6 x 7 - 21 x 23 mm
		0442	1.5 - 10 mm
		2061	90°
		2065	50, 100 mm
		2068	
		2073	150 mm
		2075	4 - 13 mm
		2076	4 - 5,5 - 7
		2077	PH 1 - 2 - 3
		2078	3 - 4 - 5 - 6 - 8
		2083	10 3/8
		2084	13 1/4
		2090	E4 - E8, E10, E11
		2092	T8 - T40
		7052	Bitbox 32 pcs
		3061	90°
		3065	125, 250 mm
		3068	
		3075	6 - 22 mm
		3083	12.5 mm 1/2
		4061	90°
		4064	300 mm
		4065	125, 250 mm
		4068	
		4075	10 - 32 mm
		3078	4 - 8, 10 x 48 mm 4 - 8, 10 x 92 mm
		3079	M5 - M6 - M8 - M10 x 48, M8 - M10 x 92 mm
		3092	T15 - 55 x 48 mm T15 - 55 x 92 mm
		0372	5/8 x 16 x 270 mm
		0383	14 x 250 mm
		0568	205 mm
		0633	6 - 24 V
		0760	13 x 0,05 - 1,00
		0781	
		3081	14 - 16 - 18 - 20,8
		4082	10 3/8
		4078	4 - 19 x 62 mm 4 - 12 x 100 mm
		0443	T10 - T50
		4090	E10 - E24
		4092	T20 - T80 x 62 mm T20 - T80 x 100 mm
		0500	180 mm (7")
		0530	180 mm (7")
		0556	240 mm (10")
		0585	205 mm (8")
			A2, A21, J2, J21
		0660	0.5 x 3 mm
		0615	0.8 x 5 - 1.0 x 5.5 1.2 x 6,5 mm
		0635	3 mm
		0655	PH 0 - PH 1 - PH 2
		0640	0.8 x 4 x 25 mm/PH1
		0620	T10 - T40
		0705	500 g
		0717	120 x 4 x 10 mm
		0718	3 - 4 - 5 - 6 mm
		0738	115 x 65 mm



The tool assortment **AUTOMOTIVE PRO** is a **comprehensive selection of tools for your workshop** (as recommended by **Ford** and **Jaguar Land Rover**) and has been compiled by many experts.

It contains:

- Socket set with 6.3 mm (1/4"), 10 mm (3/8") and 12.5 mm (1/2") drive, all sockets from 4 - 32 mm
- Comprehensive assortment of screwdriver sockets for slotted, PH, hex and TORX® screws E4 - E24, T8 - T55
- Tool set for spark plugs
- Plier set with **3KsoftGrip** handles
- Circlip plier set
- Comprehensive screwdriver set with 2-component handles for slotted, PH and TORX® screws
- Mechanic's set with the most important striking tools
- etc.



The detailed specification can be found at [www.matador.de](http://www.matador.de).

Tool assortment **AUTOMOTIVE PRO** + Tool Trolley **RATIO** (7 drawers)

ART. CODE  
8163 9580

# Tool trolley **RATIO „Ford edition“** with **275 high quality tools.**

The perfect assortment for the Ford workshop.

6,3 <sup>1</sup>/<sub>4</sub> 10 <sup>3</sup>/<sub>8</sub> 12,5 <sup>1</sup>/<sub>2</sub>

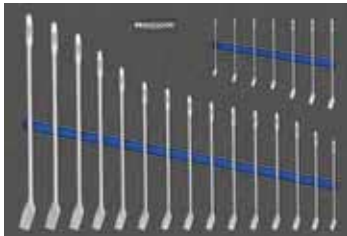

8164 3185

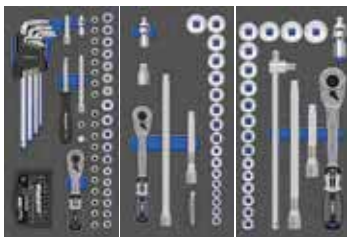

8164 1201

8164 1301

8164 1401

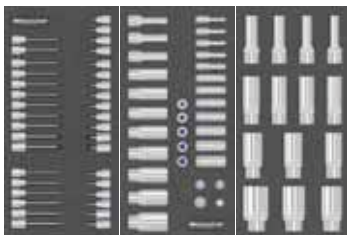

8164 3078

8164 3082

8164 4081

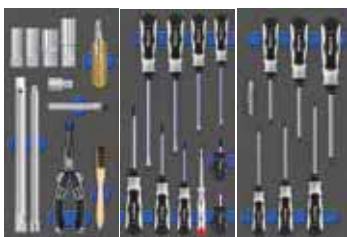

8164 3081

8164 1615

8164 1620



8164 1500

8164 1504

8164 1706



Tool trolley **RATIO** with 7 drawers, **including 275 high quality tools** in 5 drawers with **2-coloured MTS modules** („See what is missing“), e.g. with:

- Combination Spanners angled DIN 3113 A 6 - 34 mm
- Socket set with 6,3 mm (1/4“), 10 mm (3/8“) and 12,5 mm (1/2“) drive, sockets 4 - 32 mm
- **Premium Z 90** ratchets with 90 teeth for only 4° angle, 50% more torque than DIN standards
- Deep Sockets with 10 mm (3/8“) and 12,5 mm (1/2“) drive, 4 - 32 mm
- Screwdriver Sockets for slotted, PH and hex screws (4 - 10 mm), TORX® screws E4 - E14 und T8 - T55 (from T15 each in short and long type)
- Spark Plug Tool Set
- 16 pc. screwdrivers Set, also with TORX®
- 4 pc. set of pliers with 3 component pliers
- 4 pc. set of Circlip Pliers
- Mechanic`s Tools Kit



With innovative Z 90 ratchets with multi component handles.



Sockets in 5 star industrial quality with **SUPER CHROM** surface.



**3KsoftGRIP**

Innovative pliers set with 3KsoftGRIP handles and many special features.



**2K**

High-quality screwdrivers set with ergonomic 2C handles.



Torsion bitbox with 32 pieces. Absorbs the power peaks.





# Tool trolley **RATIO „Mercedes-Benz edition“** with **413 high quality tools.**

The perfect assortment for the Mercedes-Benz workshop.

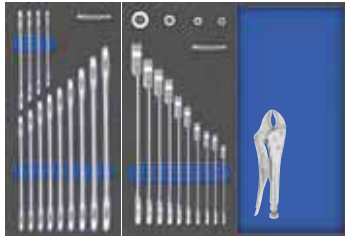

8164 3100 8164 1183 8164 0095

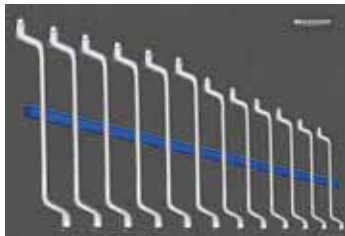

8164 1200

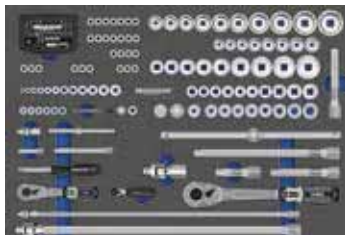

8164 1214



8164 1492

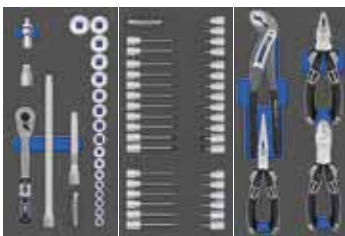

8164 1301 8164 3078 8164 1500

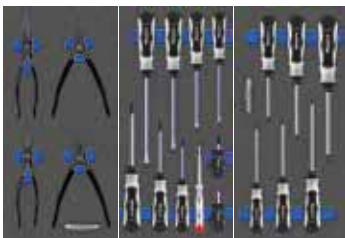

8164 1504 8164 1615 8164 1620



Comprehensive tool kit with **413 premium tools** by MATADOR especially for Mercedes-Benz car workshops. **The best or nothing...**

Based on the **MB standard tool kit** and supplemented by all important automotive tools, this new universal kit covers all central maintenance work. Among other things with:

- Double open ended spanners 6x7 - 30x32 mm
- **Combination ratchet spanners with extremely fine toothed gear mechanism (120 teeth = 3°)** 6 - 22 mm
- Double ended ring spanners 6x7 - 30x32 mm
- **Premium Z90** ratchets with 90 teeth for only 4° angle
- 145 pcs socket set 4 - 32 mm
- Comprehensive assortment of screwdriver sockets for slotted, PH, hex, TORX® and XZN screws
- 32 pcs **torsion bit set** for extra long service life with color coding system
- L-key wrenches set with ball point head
- Plier set with **3KsoftGrip** handles
- Screwdrivers set for slotted, PH and TORX® screws
- Mechanic's set with the most important striking tools
- Special automotive set with magnetic pick up tool, spark plug sockets, nut drivers with t-handle, impact sockets, sealing scrapers, etc.

Including:

- **Oil filter socket 36 mm MB** (similar W 103 589 02 09 00)
- **Shock absorber tools MB 24 pcs in a plastic case** (similar W 001 589 03 16 00)



The detailed specification can be found at [www.matador.de](http://www.matador.de).

Tool assortment **and** Tool trolley **RATIO** with 8 drawers

ART. CODE  
**8163 9590**

# MTS modules.

Perfectly organized. See what's missing.

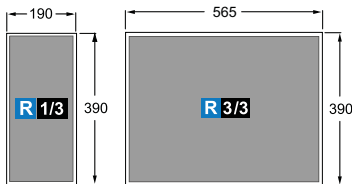

**MTS** MATADOR TOOL SYSTEM.

■ Set of Double Open Ended Spanners XL, DIN 3110, 8 pcs

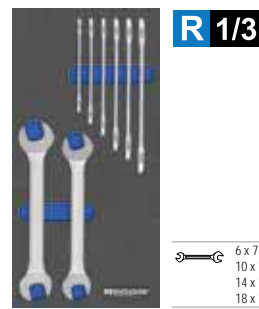

- 6 x 7 - 8 x 9
- 10 x 11 - 12 x 13
- 14 x 15 - 16 x 17
- 18 x 19 - 20 x 22

ART. CODE **8**  
8164 1100

■ Set of Double Open Ended Spanners XL, DIN 3110, 13 pcs

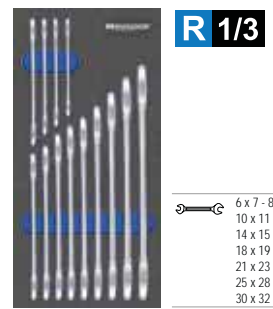

- 6 x 7 - 8 x 9
- 10 x 11 - 12 x 13
- 14 x 15 - 16 x 17
- 18 x 19 - 20 x 22
- 21 x 23 - 24 x 26
- 25 x 28 - 27 x 30
- 30 x 32 mm

ART. CODE **13**  
8164 3100

■ Set of Combination Ratchet Spanners with Adapters, 14 pcs

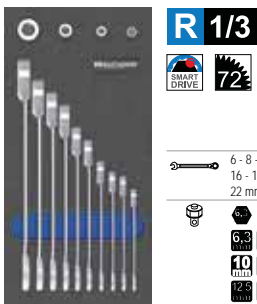

- 6 - 8 - 10 - 11 - 13
- 16 - 17 - 18 - 19
- 22 mm
- 6.3 1/4
- 10 3/8
- 12.5 1/2

ART. CODE **14**  
8164 1183

■ Set of Combination Spanners DIN 3113 A, 9 pcs

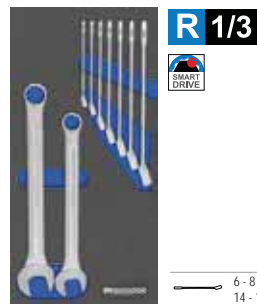

- 6 - 8 - 10 - 11 - 13
- 14 - 17 - 19 - 22

ART. CODE **9**  
8164 1185

■ Set of Combination Spanners DIN 3113 B, 9 pcs

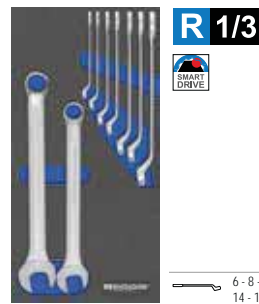

- 6 - 8 - 10 - 11 - 13
- 14 - 17 - 19 - 22

ART. CODE **9**  
8164 1190

■ Set of Pipe Head Spanners 12 pcs

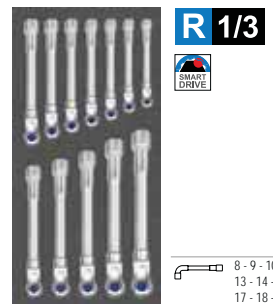

- 8 - 9 - 10 - 11 - 12
- 13 - 14 - 15 - 16
- 17 - 18 - 19 mm

ART. CODE **12**  
8164 1320

■ Set of Combination Ratchet Spanners XL, 23 pcs

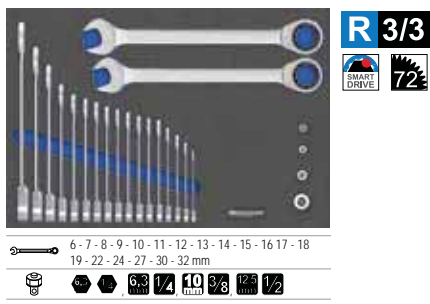

- 6 - 7 - 8 - 9 - 10 - 11 - 12 - 13 - 14 - 15 - 16 17 - 18
- 19 - 22 - 24 - 27 - 30 - 32 mm
- 6.3 1/4
- 10 3/8
- 12.5 1/2

ART. CODE **23**  
8164 2183

■ Set of Combination Spanners XL DIN 3113 A, 22 pcs

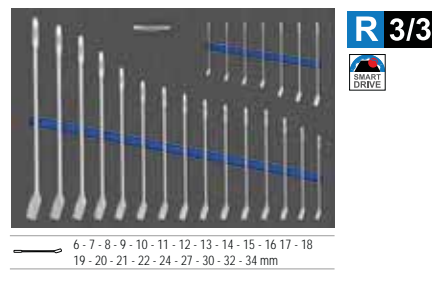

- 6 - 7 - 8 - 9 - 10 - 11 - 12 - 13 - 14 - 15 - 16 17 - 18
- 19 - 20 - 21 - 22 - 24 - 27 - 30 - 32 - 34 mm

ART. CODE **22**  
8164 3185

■ Set of Combination Spanners XL DIN 3113 B, 26 pcs

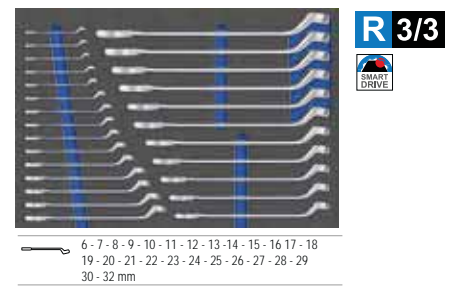

- 6 - 7 - 8 - 9 - 10 - 11 - 12 - 13 - 14 - 15 - 16 17 - 18
- 19 - 20 - 21 - 22 - 23 - 24 - 25 - 26 - 27 - 28 - 29
- 30 - 32 mm

ART. CODE **26**  
8164 3190

■ Set of Double Ended Ring Spanners DIN 838, 12 pcs

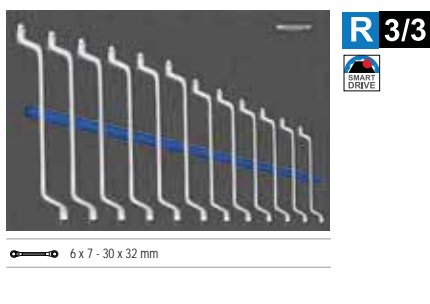

- 6 x 7 - 30 x 32 mm

ART. CODE **12**  
8164 1200

■ Set of Spanners and Combination Ratchet Spanners, 34 pcs

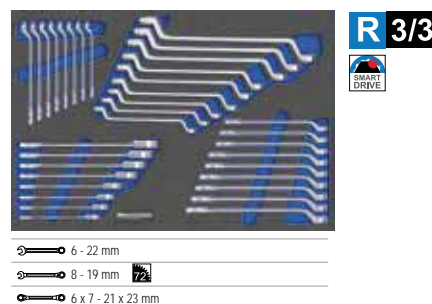

- 6 - 22 mm
- 8 - 19 mm
- 6 x 7 - 21 x 23 mm

ART. CODE **34**  
8164 1195

■ Supplementary Spanners Set 15 pcs

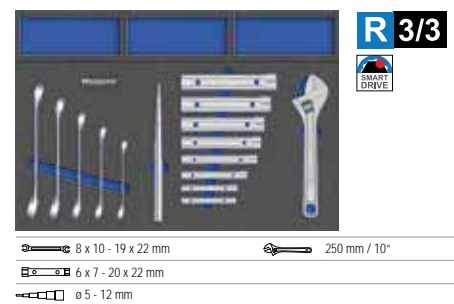

- 8 x 10 - 19 x 22 mm
- 250 mm / 10"
- 6 x 7 - 20 x 22 mm
- ø 5 - 12 mm

ART. CODE **15**  
8164 1251



■ Set of Nut Drivers with T-Handle, 3 pcs



R 1/3

6 - 7 - 8 x 230

ART. CODE **3**  
8164 1671

■ Set of Nut Drivers with T-Handle, 3 pcs



R 1/3

9 - 10 - 11 x 230

ART. CODE **3**  
8164 2671

■ Set of Nut Drivers with T-Handle, 3 pcs



R 1/3

12 - 13 - 14 x 230

ART. CODE **3**  
8164 3671

■ Set of Nut Drivers with T-Handle, 3 pcs



R 1/3

8 - 10 - 13 x 230

ART. CODE **3**  
8164 4671

■ Socket Set 85 pcs

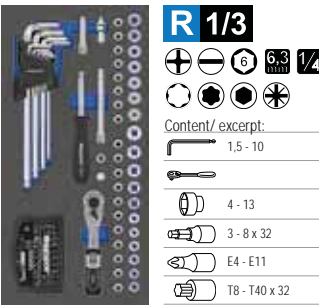

R 1/3

6.3 mm 1/4  
10 mm 3/8  
12.5 mm 1/2

Content/ excerpt:  
1.5 - 10

4 - 13  
3 - 8 x 32  
E4 - E11  
T8 - T40 x 32

ART. CODE **85**  
8164 1201

■ Socket Set 22 pcs

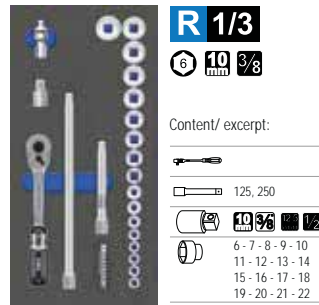

R 1/3

10 mm 3/8  
12.5 mm 1/2  
15 mm 3/4

Content/ excerpt:  
125, 250

6 - 7 - 8 - 9 - 10  
11 - 12 - 13 - 14  
15 - 16 - 17 - 18  
19 - 20 - 21 - 22

ART. CODE **22**  
8164 1301

■ Screwdriver Sockets Hex, TORX®, XZN, 36 pcs

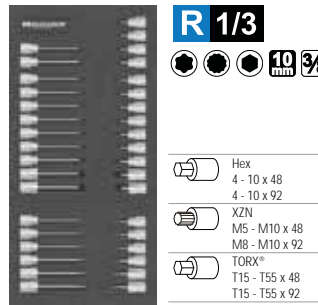

R 1/3

10 mm 3/8  
12.5 mm 1/2  
15 mm 3/4

Hex  
4 - 10 x 48  
4 - 10 x 92  
XZN  
M5 - M10 x 48  
M8 - M10 x 92  
TORX®  
T15 - T55 x 48  
T15 - T55 x 92

ART. CODE **36**  
8164 3078

■ Tool Set for Spark Plugs 11 pcs

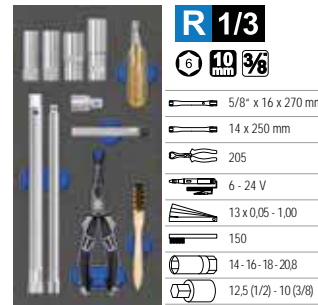

R 1/3

10 mm 3/8  
12.5 mm 1/2  
15 mm 3/4

5/8" x 16 x 270 mm  
14 x 250 mm  
205  
6 - 24 V  
13 x 0,05 - 1,00  
150  
14 - 16 - 18 - 208  
12,5 (1/2) - 10 (3/8)

ART. CODE **11**  
8164 3081

■ Socket Set (long type), 32 pcs

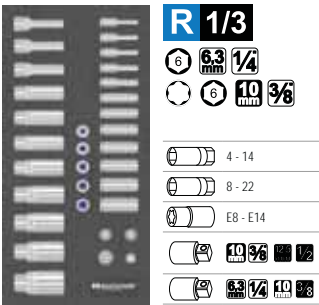

R 1/3

6.3 mm 1/4  
10 mm 3/8  
12.5 mm 1/2

4 - 14  
8 - 22  
E8 - E14  
10 mm 3/8  
12.5 mm 1/2  
15 mm 3/4

ART. CODE **32**  
8164 3082

■ Screwdriver Sockets 28 pcs

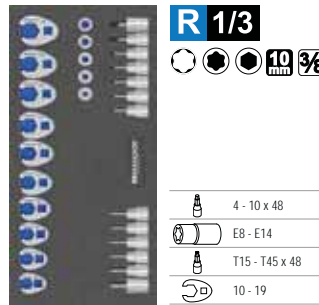

R 1/3

10 mm 3/8  
12.5 mm 1/2  
15 mm 3/4

4 - 10 x 48  
E8 - E14  
T15 - T45 x 48  
10 - 19

ART. CODE **28**  
8164 3093

■ Socket Set 22 pcs

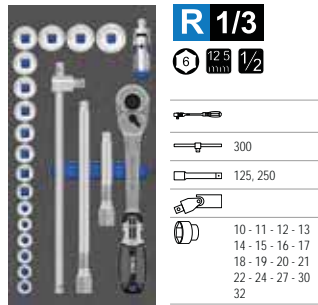

R 1/3

12.5 mm 1/2  
15 mm 3/4

300  
125, 250  
10 - 11 - 12 - 13  
14 - 15 - 16 - 17  
18 - 19 - 20 - 21  
22 - 24 - 27 - 30  
32

ART. CODE **22**  
8164 1401

■ Socket Set (long type) 14 pcs

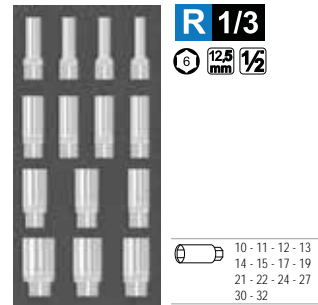

R 1/3

12.5 mm 1/2  
15 mm 3/4

10 - 11 - 12 - 13  
14 - 15 - 17 - 19  
21 - 22 - 24 - 27  
30 - 32

ART. CODE **14**  
8164 4081

■ Supplementary Set 16 pcs

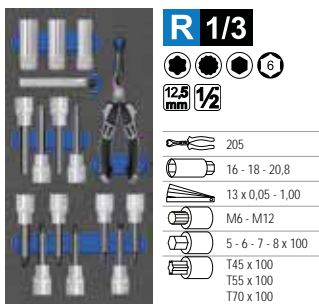

R 1/3

12.5 mm 1/2  
15 mm 3/4

205  
16 - 18 - 20,8  
13 x 0,05 - 1,00  
M6 - M12  
5 - 6 - 7 - 8 x 100  
T45 x 100  
T55 x 100  
T70 x 100

ART. CODE **16**  
8164 1481

■ Screwdriver Sockets 17 pcs

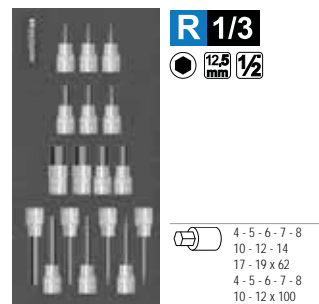

R 1/3

12.5 mm 1/2  
15 mm 3/4

4 - 5 - 6 - 7 - 8  
10 - 12 - 14  
17 - 19 x 62  
4 - 5 - 6 - 7 - 8  
10 - 12 x 100

ART. CODE **17**  
8164 4078

■ Screwdriver Sockets, XZN/RIBE®, 21 pcs

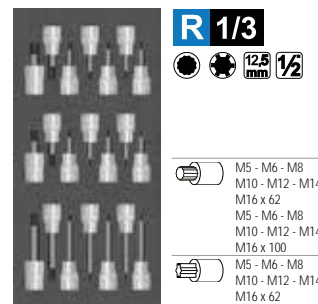

R 1/3

12.5 mm 1/2  
15 mm 3/4

M5 - M6 - M8  
M10 - M12 - M14  
M16 x 62  
M5 - M6 - M8  
M10 - M12 - M14  
M16 x 100  
M5 - M6 - M8  
M10 - M12 - M14  
M16 x 62

ART. CODE **21**  
8164 4079

■ Screwdriver Sockets, TORX®, 39 pcs

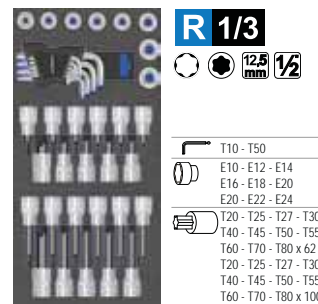

R 1/3

12.5 mm 1/2  
15 mm 3/4

T10 - T50  
E10 - E12 - E14  
E16 - E18 - E20  
E20 - E22 - E24  
T20 - T25 - T27 - T30  
T40 - T45 - T50 - T55  
T60 - T70 - T80 x 62  
T20 - T25 - T27 - T30  
T40 - T45 - T50 - T55  
T60 - T70 - T80 x 100

ART. CODE **39**  
8164 4092

**Impact Sockets (short type)**  
24 pcs

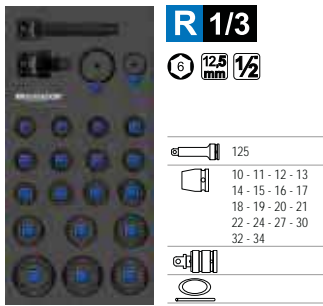

**R 1/3**  
6 12.5 mm 1/2

- 125
- 10 - 11 - 12 - 13
- 14 - 15 - 16 - 17
- 18 - 19 - 20 - 21
- 22 - 24 - 27 - 30
- 32 - 34

ART. CODE **24**  
8164 7475

**Impact Sockets (long type)**  
19 pcs

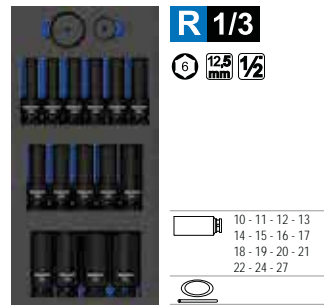

**R 1/3**  
6 12.5 mm 1/2

- 10 - 11 - 12 - 13
- 14 - 15 - 16 - 17
- 18 - 19 - 20 - 21
- 22 - 24 - 27

ART. CODE **19**  
8164 7481

**Impact Sockets**  
14 pcs

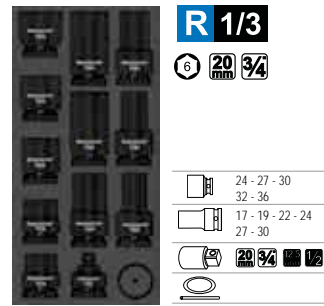

**R 1/3**  
6 20 mm 3/4

- 24 - 27 - 30
- 32 - 36
- 17 - 19 - 22 - 24
- 27 - 30

ART. CODE **14**  
8164 7575

**Pneumatic Tool Set**  
2 pcs



**R 1/3**  
12.5 mm 1/2

- 1.490 N·m

ART. CODE **2**  
8164 1700

**Set of Nut Drivers with T-Handle**  
15 pcs

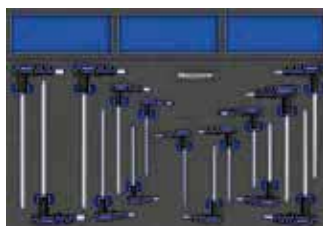

**R 3/3**  
6 6

- 2 - 3 - 4 - 5 - 6 - 8 - 10
- T10 - T15 - T20 - T25 - T27 - T30 - T40 - T45

ART. CODE **15**  
8164 1441

**Socket Set L**  
72 pcs

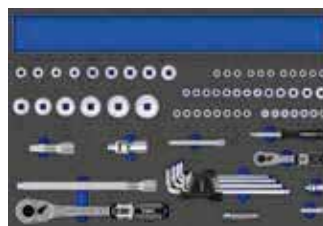

**R 3/3**  
6.3 mm 1/4  
12.5 mm 1/2  
6 6

- 1.5 - 10
- 4 - 32

ART. CODE **72**  
8164 1411

**Socket Set XL**  
120 pcs

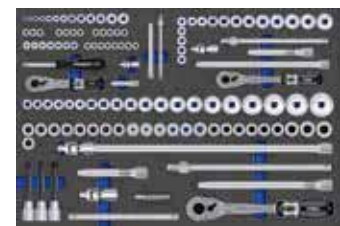

**R 3/3**  
6.3 mm 1/4  
10 mm 3/8  
12.5 mm 1/2  
6 6

- E4 - E24
- 4 - 32
- T8 - T70

ART. CODE **120**  
8164 1421

**Pliers Set**  
4 pcs



**R 1/3** **3K**

- 180 (7")
- 180 (7")
- 240
- 205 (8")

ART. CODE **4**  
8164 1500

**Pliers Set**  
4 pcs



**R 1/3** **3K**

- 180 (7")
- 180 (7")
- 240
- 205 (8")

ART. CODE **4**  
8164 1501

**Circlip Pliers Set**  
4 pcs

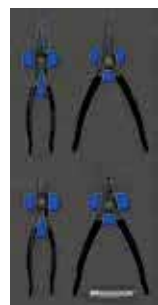

**R 1/3**

- A2 U 19 - 60 mm
- A21 U 19 - 60 mm
- J2 O 19 - 60 mm
- J21 O 19 - 60 mm

ART. CODE **4**  
8164 1504

**Circlip Pliers Set XL**  
4 pcs



**R 1/3**

- A3 U 40 - 100 mm
- A31 U 40 - 100 mm
- J3 O 40 - 100 mm
- J31 O 40 - 100 mm

ART. CODE **4**  
8164 1505

**Screwdriver Set**  
10 pcs



**R 1/3**

- 0.5 x 3 x 100
- 0.8 x 5 x 100
- 1.0 x 5.5 x 125
- 1.2 x 6.5 x 150
- PH 0 - PH 1 - PH 2
- 3
- 0.8 x 4 x 25
- PH 1

ART. CODE **10**  
8164 1615

**Screwdriver Set (TORX®), 6 pcs**



**R 1/3**

- T10 - T15 x 80
- T20 x 90
- T25 x 100
- T30 x 115
- T40 x 120

ART. CODE **6**  
8164 1620

**Screwdriver Set with Striking Cap, 6 pcs**



**R 1/3**

- 1.0 x 5.5 x 100
- 1.2 x 8 x 150
- 2.0 x 12 x 200
- PH 1 - PH 2 - PH 3

ART. CODE **6**  
8164 1653

**Precision Tool Set**  
17 pcs

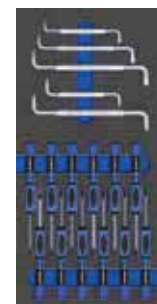

**R 1/3**

- 4 - 5.5 - 8
- PH 1 - PH 2
- PH 3 - PH 4
- 0.25 x 1.0 x 50
- 0.4 x 2.0 x 50
- 0.5 x 3.0 x 50
- PH 00 - PH 0 - PH 1
- T5 - T15

ART. CODE **17**  
8164 1663



**Pliers Set VDE**  
4 pcs

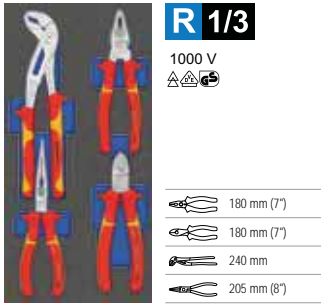

**R 1/3**

1000 V  
⚡ ⚡ ⚡

- 180 mm (7")
- 180 mm (7")
- 240 mm
- 205 mm (8")

ART. CODE **4**  
8164 1502

**Pliers Set VDE**  
4 pcs

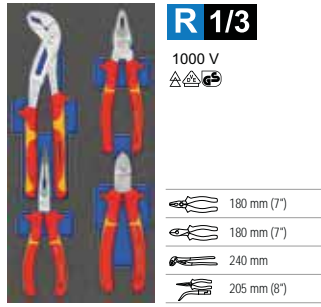

**R 1/3**

1000 V  
⚡ ⚡ ⚡

- 180 mm (7")
- 180 mm (7")
- 240 mm
- 205 mm (8")

ART. CODE **4**  
8164 1503

**Screwdriver Set VDE**  
10 pcs

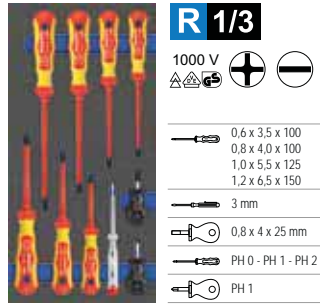

**R 1/3**

1000 V  
⚡ ⚡ ⚡

- 0,6 x 3,5 x 100
- 0,8 x 4,0 x 100
- 1,0 x 5,5 x 125
- 1,2 x 6,5 x 150
- 3 mm
- 0,8 x 4 x 25 mm
- PH 0 - PH 1 - PH 2
- PH 1

ART. CODE **10**  
8164 1616

**File Set**  
5 pcs

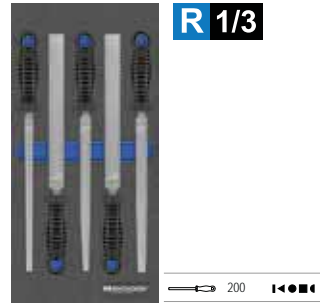

**R 1/3**

- 200

ART. CODE **5**  
8164 1775

**Mechanic's Tools Basic**  
11 pcs

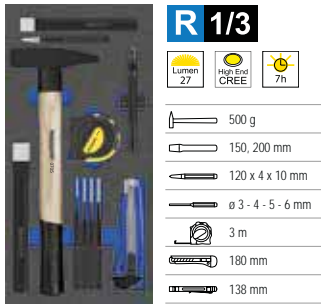

**R 1/3**

Lumen 27  
High End CREE  
7h

- 500 g
- 150, 200 mm
- 120 x 4 x 10 mm
- ø 3 - 4 - 5 - 6 mm
- 3 m
- 180 mm
- 138 mm

ART. CODE **11**  
8164 1701

**Mechanic's Tools Supplement, 7 pcs**

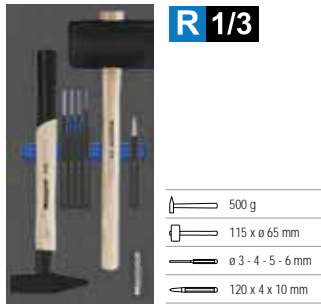

**R 1/3**

- 500 g
- 115 x ø 65 mm
- ø 3 - 4 - 5 - 6 mm
- 120 x 4 x 10 mm

ART. CODE **7**  
8164 1707

**Torque Tool Set 9 x 12**  
18 pcs

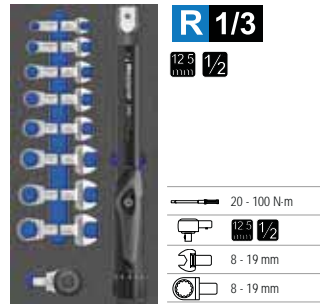

**R 1/3**

12,5 mm 1/2

- 20 - 100 N-m
- 12,5 mm 1/2
- 8 - 19 mm
- 8 - 19 mm

ART. CODE **18**  
8164 6176

**Torque Tool Set 9 x 12**  
17 pcs

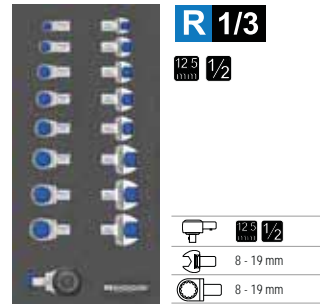

**R 1/3**

12,5 mm 1/2

- 12,5 mm 1/2
- 8 - 19 mm
- 8 - 19 mm

ART. CODE **17**  
8164 6190

**Mechanic's Tools**  
25 pcs



**R 3/3**

- 500, 1.000 g
- ø 3 - 10 mm
- 125 - 175 - 200
- ø 22, 35
- 120 x 4 x 10
- ø 2 - 10
- ø 40 mm
- 125 - 175 - 200

ART. CODE **25**  
8164 1705

**Mechanic's Tools**  
12 pcs

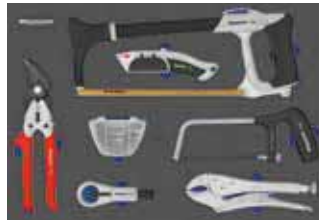

**R 3/3**

- 10" / 250
- 8 - 24
- 250 mm
- R
- 180 mm
- M3 - M24
- 440 mm

ART. CODE **12**  
8164 1786

**Measuring Instruments**  
11 pcs

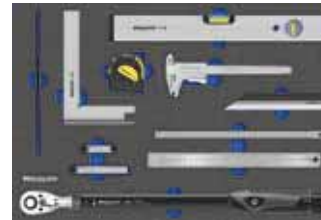

**R 3/3**

- 40 - 200 N-m
- 150 mm
- 400 mm
- 3 m
- 52 x 0,25 - 6,00
- 300 mm
- 250 mm
- 20 x 0,05 - 1,00
- 200 x 130 mm

ART. CODE **11**  
8164 1798

**Truck Set**  
19 pcs



**R 3/3**

- 24 x 27 - 25 x 28 - 30 x 32 mm
- 1,2 - 1,6 - 2,0
- 24 - 27 - 30 - 32 mm
- PH 2 - PH 3 - PH 4
- 24 x 27 - 25 x 28 - 30 x 32 mm
- ø 40 mm / 750 g

ART. CODE **19**  
8164 1708

**Self Cutting Module**



**R 3/3**

- For cutting individual tool modules
- 580 x 390 mm

ART. CODE  
8164 9999

**Empty Module**



**R 1/3**

- 1/3 empty module for individual tools
- 195 x 390 mm

ART. CODE  
8164 0095

## ■ SPANNERS



- ☑ High Industrial Quality
- ☑ For 24/7 usage
- ☑ Dimensionally accurate, precise and stable: for safe working



All 8 and 12 pcs sets come in a stable premium rollbag with water-resistant surface and comfortable Velcro straps.



### ■ Double Open Ended Spanners, DIN 3110



### ■ Combination Spanners, DIN 3113 A



With angled ring side.

0185 8 - 10 - 11 - 13 - 14 - 17 - 19  
22 mm

**8-22**

ART. CODE  
0185 9080

0185 8 - 9 - 10 - 11 - 12 - 13 - 14 - 15  
16 - 17 - 18 - 19 mm

**8-19**

ART. CODE  
0185 9123

0185 6 - 7 - 8 - 9 - 10 - 11 - 13 - 14  
17 - 19 - 20 - 22 mm

**6-22**

ART. CODE  
0185 9120

0185 6 - 7 - 8 - 9 - 10 - 11 - 12 - 13  
14 - 17 - 19 - 22 - 24 - 27 - 30  
32 mm

**6-32**

ART. CODE  
0185 9160

### ■ Combination Spanners, DIN 3113 B, offset



With offset ring side for deep-set screw joints.

0190 8 - 9 - 10 - 11 - 12 - 13 - 14 - 15  
16 - 17 - 18 - 19 mm

**8-19**

ART. CODE  
0190 9120

0190 6 - 7 - 8 - 9 - 10 - 11 - 13 - 14  
17 - 19 - 20 - 22 mm

**6-22**

ART. CODE  
0190 9121

0190 6 - 7 - 8 - 9 - 10 - 11 - 12 - 13  
14 - 17 - 19 - 22 - 24 - 27 - 30  
32 mm

**6-32**

ART. CODE  
0190 9160

### ■ Double Ended Ring Spanners, DIN 838



With deeply offset double ring profile.

0200 6 x 7 - 8 x 9 - 10 x 11  
12 x 13 - 14 x 15 - 16 x 17  
18 x 19 - 20 x 22 mm

**6-22**

ART. CODE  
0200 9080

0200 6 x 7 - 8 x 9 - 10 x 11  
12 x 13 - 14 x 15 - 16 x 17  
18 x 19 - 20 x 22 - 21 x 23  
24 x 27 - 25 x 28 - 30 x 32 mm

**6-32**

ART. CODE  
0200 9120

Ideal for stud bolts.  
With flat heads.

0100 6 x 7 - 8 x 9 - 10 x 11 - 12 x 13  
14 x 15 - 16 x 17 - 18 x 19  
20 x 22 mm

**6-22**

ART. CODE  
0100 9080

0100 6 x 7 - 8 x 9 - 10 x 11 - 12 x 13  
14 x 15 - 16 x 17 - 18 x 19  
20 x 22 - 21 x 23 - 24 x 27  
25 x 28 - 30 x 32 mm

**6-32**

ART. CODE  
0100 9120



# HIT deals

Our classics at the best price.

## ■ RATCHET SPANNERS

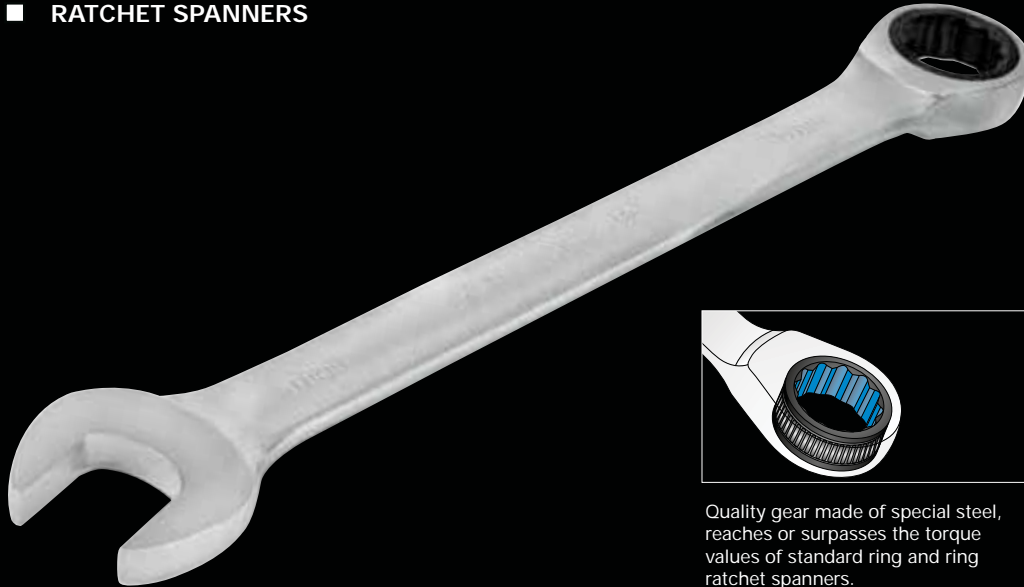

The original with patented GearWrench®-gear.

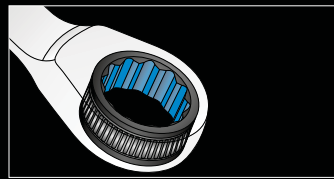

Quality gear made of special steel, reaches or surpasses the torque values of standard ring and ring ratchet spanners.



Ratcheting angle of only 5° due to 72 teeth, quick results even in confined spaces.

## ■ Combination Ratchet Spanners, straight



Straight type, without switch lever, end position 15° angled, MATADOR SUPER CHROM, CrV-Steel.

	0183 8 - 10 - 13 - 17 - 19 mm
<b>8-19</b>	
ART. CODE	
0183 9050	

	0183 8 - 9 - 10 - 11 - 12 - 13 - 14 - 15 - 16 - 17 - 18 - 19 mm
<b>8-19</b>	
ART. CODE	
0183 9120	

## ■ 4in1Ratchet Spanner



Suitable for 70% of all screw tasks.

2 sizes per side, simply turn for bi-directional tightening.



	0184 10 - 13 - 17 - 19 mm
<b>10-19</b>	
ART. CODE	
0184 0001	



## MATADOR Sockets 6 Stars-Comfort



Chrome Vanadium Steel for high tenacity, exceeds temper values demanded according to DIN.



SUPER CHROM coating for perfect rust protection, cannot flake off.



Double Smart Drive profile both on hexagon and square side is gentle on the screw. And what's even more important: On the ratchet.

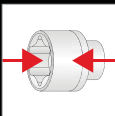

Double coating inside and outside, does not transfer surface rust.

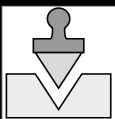

Stamped mark (not only lasered) for permanent identification and manufacturer's notification.

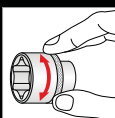

Knurled zone for manual high-speed turning even with oily fingers.

## Socket Set 16 pcs



- With fine-toothed reversible ratchet
- In solid metal case, durable quality, black powder coated

2061 Reversible Ratchet

2064 115 mm

2065 100 mm

2068

2073 150 mm

2075 4 - 4.5 - 5 - 5.5 - 6 - 7 - 8 - 9 - 10 - 11 - 13 mm

ART. CODE

2115 9160

## Socket Set 28 pcs



- With fine-toothed reversible ratchet
- In solid metal case, durable quality, black powder coated

2061 Reversible Ratchet

2064 115 mm

2065 50, 100 mm

2068

2073 150 mm

2075 4 - 4.5 - 5 - 5.5 - 6 - 7 - 8 - 9 - 10 - 11 - 13 mm

2076 4 - 5.5 - 7 x 32 mm

2077 PH 1 - PH 2 - PH 3 x 32 mm

2078 3 - 4 - 5 - 6 - 8 x 32 mm

ART. CODE

2135 9280

## Socket Set 21 pcs

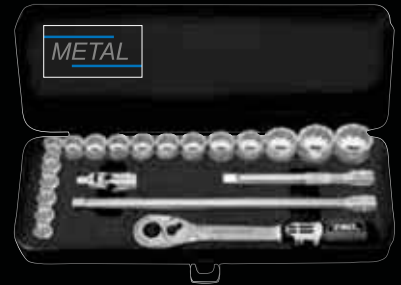

3061 Reversible Ratchet

3065 125, 250 mm

3068

3075 6 - 7 - 8 - 9 - 10 - 11 - 12 - 13 - 14 - 15 - 16 - 17 18 - 19 - 20 - 21 - 22 mm

ART. CODE

3115 9210

ART. CODE

3115 9211

## Socket Set 39 pcs



3061 Reversible Ratchet

3065 125, 250 mm

3068

3075 6 - 7 - 8 - 9 - 10 - 11 - 12 - 13 - 14 - 15 - 16 - 17 18 - 19 - 20 - 21 - 22 mm

3078 4 - 5 - 6 - 7 - 8 - 10 x 48 mm

3090 E8 - E10 - E11 - E12 - E14

3092 T15 - T20 - T25 - T27 - T30 - T40 - T45 x 48 mm

ART. CODE

3125 9390

ART. CODE

3125 9391



# HIT deals

Our classics at the best price.



All sockets sets including the new **Z90**

■ Socket Set 23 pcs

**1/2"**



			4061	Reversible Ratchet	
			4064	300 mm	
			4065	125, 250 mm	
			4068		
			4075	10 - 11 - 12 - 13 - 14 - 15 - 16 - 17 - 18 - 19 - 20 - 21 - 22 - 23 - 24 - 27 - 30 - 32 mm	
ART. CODE					
4114 9230					
ART. CODE					
4114 9231					

■ Socket Set 61 pcs

**1/4" 1/2"**



			2061	Reversible Ratchet	
			2065	50 mm	
			2068		
			2073	150 mm	
			2075	4 - 4.5 - 5 - 5.5 - 6 - 7 - 8 - 9 - 10 - 11 - 12 - 13 14 mm	
			2076	4 - 5.5 - 7 x 32 mm	
			2077	PH 1 - PH 2 x 32 mm	
			2077	PZ 1 - PZ 2 x 32 mm	
			2078	3 - 4 - 5 - 6 - 8 x 32 mm	
			2090	E4 - E5 - E6 - E8	
			2092	T10 - T15 - T20 - T25 - T27 - T30 x 32 mm	
			4061	Reversible Ratchet	
			4065	125, 250 mm	
			4068		
			4075	10 - 11 - 12 - 13 - 14 - 15 - 16 - 17 - 18 - 19 - 20 - 21 - 22 - 23 - 24 - 27 - 30 - 32 mm	
ART. CODE					
4118 9230					
ART. CODE					
4118 9231					

■ Screwdriver Bit Sockets (Hex) 9 pcs

**1/2"**



			4078	5 - 6 - 7 - 8 - 10 - 12 - 14 - 17 - 19 x 62 mm
ART. CODE				
4078 9090				

■ Screwdriver Bit Sockets (TORX®) 9 pcs

**1/2"**



			4092	T20 - T25 - T27 - T30 - T40 - T45 - T50 - T55 - T60 x 62 mm
ART. CODE				
4092 9090				

■ Fine-toothed Reversible Ratchets

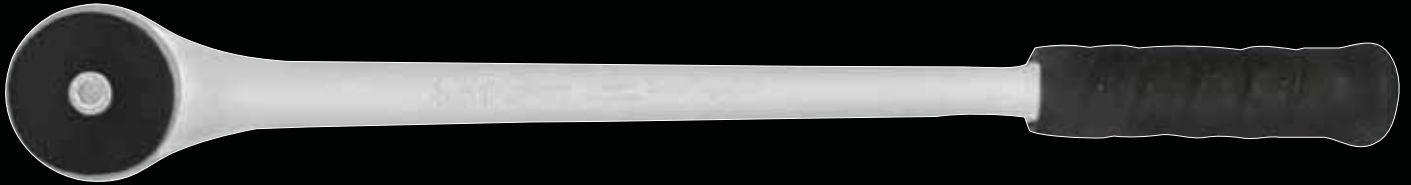

For heavy duty use in industry and workshop. Chrome Vanadium steel, precisely hot forged. High performance gear technology with **precise 72 teeth** for only 5° swivel angle. **Very powerful** and strong due to 18 teeth in mesh during torquing, **reached over 1.600 N·m**. **Ergonomic handle** useable with both hands.

20 3/4 5060 510 mm

ART. CODE  
5060 0001

■ Socket Set  
16 pcs

3/4



- With **push-through ratchet 5062**
- 12 pieces of sockets 22 - 60 mm
- With black MFS soft foam inlay, resistant against oil and lubricants
- In solid metal case, durable quality, black powder coated

20 3/4 5062 510 mm Push-Through Ratchet 36

20 3/4 5064 500 mm

20 3/4 5065 20 3/4 200, 400 mm

20 3/4 5075 22 - 24 - 27 - 30 - 32 - 36 - 38 - 41 - 46  
50 - 55 - 60 mm

ART. CODE  
5143 9163

ART. CODE  
5143 9164

■ Socket Set  
16 pcs



- With **reversible ratchet 5060**
- 12 pieces of sockets 22 - 60 mm
- With black MFS soft foam inlay, resistant against oil and lubricants
- In solid metal case, durable quality, black powder coated

20 3/4 5060 510 mm Reversible Ratchet 72

20 3/4 5064 500 mm

20 3/4 5065 20 3/4 200, 400 mm

20 3/4 5075 22 - 24 - 27 - 30 - 32 - 36 - 38 - 41 - 46  
50 - 55 - 60 mm

ART. CODE  
5143 9160

ART. CODE  
5143 9161

3/4

■ Socket Set  
14 pcs

1



- For trucks and heavy industry
- With **push-fit bar handle, fine-toothed**
- 10 pieces of sockets 36 - 80 mm
- In solid metal case, durable quality, black powder coated

25 1 6060 610 mm Reversible Ratchet 72

25 1 6064 640 mm

25 1 6065 25 1 200, 400 mm

25 1 6075 36 - 41 - 46 - 50 - 55 - 60 - 65 - 70 - 75 - 80 mm

ART. CODE  
6144 9140





■ **Adjustable Single Ended Spanners with scale (mm)**

Extra polished heads for precise adjustment of the jaws.

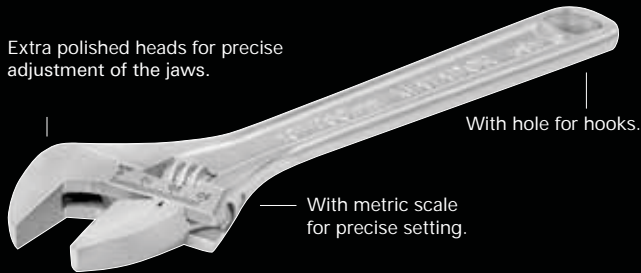

With hole for hooks.

With metric scale for precise setting.



ART. CODE	mm	mm	
		mm	"
0591 0040	1-13	100	4
0591 0060	1-20	150	6
0591 0080	1-24	200	8
0591 0100	1-30	250	10
0591 0120	1-34	300	12
0591 0150	1-43	375	15

■ **Torque Wrench ECO**



With calibration certificate according to DIN EN ISO 6789.

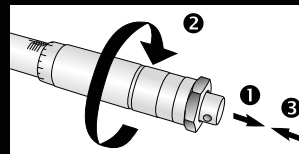

Simple adjustment by pushing and pulling the locking knob at the end of the handle.



Integrated ratchet.

22 - 350 N-m.

Robust steel handle.

ART. CODE	mm / "		N-m	lbf-ft
	mm	"		
6172 0010	10	3/8	22 - 110	2,2 - 11
6172 0020	12,5	1/2	42 - 210	4,2 - 21
6172 0030	12,5	1/2	70 - 350	7 - 35

## ■ SCREWDRIVERS / BITS

Burnished tip for precise, **durable fitting** into the screw.

**Hard, black turning zone** made of special plastic for **quick working** with low friction. **Soft** and anti-slip **grey grip zone** made of TPE plastic for **secure hold** with maximum pressure.

**Identification** at handle end.

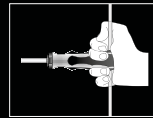

Hanging hole / T-handle mounting





Identification at handle end



## ■ Screwdriver Set 6 pcs



 0615 0,6 x 4,0 x 75 - 0,8 x 5,0 x 100 1,0 x 5,5 x 125  
1,2 x 6,5 x 150 mm

 0655 PH 1 x 80 - PH 2 x 100 mm

ART. CODE   
0680 9060

All important sizes in one 6 pcs. set of screwdrivers.

## ■ Reversible Screwdriver



 0694 1,2 x 6,0 mm - PH 2

ART. CODE  
0694 0001

Practical reversible screwdriver with black plastic handle and blade made of tool steel.

## ■ Bitbox TORSION 32 pcs





Superior lifetime, equally suitable for cordless and impact screwdrivers. Absorbs the power peaks and thus ensures more elasticity.

 3,0 - 4,0 - 5,0 - 6,0

 PH 1 - PH 2 (2x) - PH 3

 PZ 1 - PZ 2 (2x) - PZ 3

 3 - 4 - 5 - 6

 T10 - T15 - T20 - T25 - T27  
T30 - T40

 T10 - T15 - T20 - T25 - T27  
T30 - T40

 6,3 (1/4) 60 mm

 6,3 (1/4)

ART. CODE   
7052 0003



■ L-Key Wrenches

## softGRIP

Especially soft and flexible TPE material for quick and easy removal.



Ergonomic, round form with extremely rounded edges for comfortable wearing or direct working without removal.

■ Short type, 9 pcs, in slide box



For hexagon socket screws, in plastic slide box, clearly arranged for quick removal.

0440 1.5 - 2 - 2.5 - 3 - 4 - 5 - 6 - 8  
10 mm

ART. CODE  
0440 9090



■ Short type, 9 pcs, in a holder



For hexagon socket screws, in black softGRIP-holder, fully hardened.

softGRIP 0440 1.5 - 2 - 2.5 - 3 - 4 - 5 - 6 - 8  
10 mm

ART. CODE  
0440 9091



■ Long type, 9 pcs, with Ball Point Head, in a holder

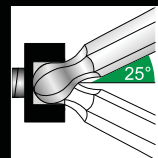

With ball point head on the long end, use in awkward areas, swivel angle up to 25°.

softGRIP 0442 1.5 - 2 - 2.5 - 3 - 4 - 5 - 6 - 8  
10 mm

ART. CODE  
0442 9091



■ Short type, 9 pcs, TORX®, in a holder

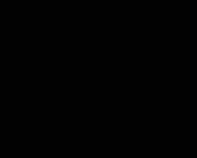

For inside TORX® screws, in black softGRIP-holder, fully hardened.

softGRIP 0443 T10 - T15 - T20 - T25 - T30 - T40  
T45 - T50

ART. CODE  
0443 9091



## Professional Hacksaw



Ergonomic handle, rubberized on both sides

With high performance saw blade made of bi-metal HSS DMo5

- High blade tension of 100 kg for straight, clean cuts with precise joints
- Lightweight aluminum frame with steel core for easy handling
- Grip with integrated clamping mechanism

ART. CODE 440  
0786 0002 mm

## Metal Saw Blade

High performance saw blade made of bi-metal HSS DMo5, 300 X 13 X 0,6 mm.

ART. CODE 300  
0786 0003 mm

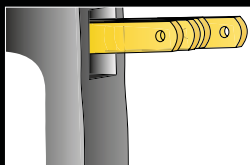

With reservoir for 9 saw blades.

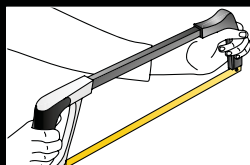

Ideal for two-hands operation.

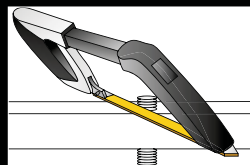

Alternative 55° blade alignment for a flush sawing of pins etc.

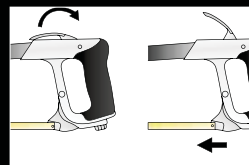

One-hand quick release mechanism.

## Screw Extractor Set 6 pcs



For extracting broken screws with right-hand thread and broken-off tube ends of fittings.

M3 - M24, 1/8 - 1"

ART. CODE 0771 0002

## Parallel Pin Punches, Set

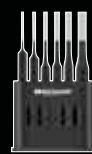

All important parallel pin punches in practical black plastic holder.

2 - 3 - 4 - 5 - 6 - 8 mm

ART. CODE 0718 9060

## Tool Set



Flat cold chisels, cross-cut chisel, center punch and taper punches in one set.

125 - 150 mm

ART. CODE 0719 9060

## Engineer's Hammer



Forged hammer head, Sideways smoothed and epoxy powdered. Handle fixed with round steel wedge and resin. With safety collar (tapered).

ART. CODE 500  
0705 0500 g

## Quality Cable Knife with wooden handle



The classic cable knife for each tool assortment. The blade folds away, with straight, hardened blade and round cable scraper. Moulded handle made out of wood. Material: Stainless steel.

ART. CODE 200  
0825 0001 mm

## Steel Wire Brush with 5 rows



Bent type, with wooden handle, wire filled in 5 rows.

ART. CODE 290  
0782 0001 mm

## Grip Pliers



For securely holding, clamping and tensioning round, profile and/or flat material

ART. CODE 250  
0588 0250 mm  
10"

■ Automotive Tools



■ Four Way Rim Wrenches for cars

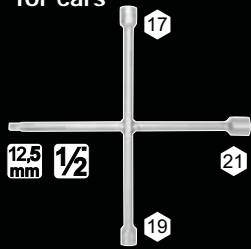

Welded version made out of chrome vanadium steel, with SK profile, works also on rounded nuts.

ART. CODE  
0350 1001

■ Wheel Bolt Cap Pliers



Special long flat nose pliers with notch, e.g. installing protective caps for aluminium wheel bolts, installation and removing blade fuses, comparable with VW 3314 / T20011.

ART. CODE  
0585 0014

■ Multi Wedge

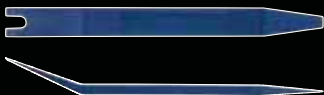

For removing panels, cover clips, carpets, etc.

Very resistant material.



ART. CODE  
0843 0004 210 mm

■ Panel Removal Kit 5 pcs



Professional trim and panel removal kit.

ART. CODE  
0843 9050

■ Strap Wrenches Pro

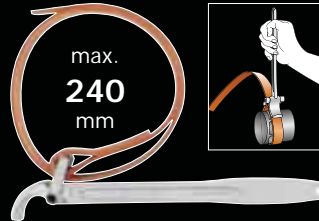

Heavy-duty construction for high torque values, for oil filters and other round shaped bodies.

ART. CODE  
0426 0001

■ Oil Filter Socket



Fits all standard oil filter cartridges.

ART. CODE  
0429 0001

■ Tyre Levers



500 mm

H-profile for high stability. For tire installation and removal, for steel and aluminium rims, also suitable for general purposes.

ART. CODE  
0754 0003

■ Release Tool



For generic works on chassis, e.g. removing door panels, fixed door windows with window guide etc. Comparable with VW T10236.

ART. CODE  
0842 0001

■ Spark Plug Brush



For cleaning of electrodes and contacts on spark plugs.

ART. CODE  
0781 0001

■ Spark Plug Wrench VW



Spark plug wrench, SW 16 mm, Comparable with VAS 3122B.

ART. CODE  
0367 0016



# Torque wrenches UNO.

One window. One value. One grip. One click.



## Make complicated things simple.



Easy setting at the end of the handle.



Only one window with clear numeric value in N·m.

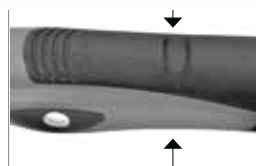

Error-free handling thanks to double-sided finger grooves.



Integrated lever ratchet with small head to reach tiny areas.



Well protected in solid plastic case.

## Extremely precise and easy to use.

The new professional torque wrench by MATADOR with an **absolutely innovative operating concept**:

**Easy setting** with extra fine graduation (from 0.5 N·m to 1.0 N·m on larger models), **only one window with clear numeric value in N·m**. No division scale which is difficult to read.

With small ratchet head to reach tiny spaces, with lever and 48 teeth, safety lock and quick-release function. Permanent protection of the body thanks to full powder coating.

The handy and ergonomically optimal design of the handle with its integrated finger grooves make the correct use a breeze. Clearly audible and perceptible signal when the desired torque value is reached.

The MATADOR UNO is extremely precise: **maximum deviation only ±3%** from the set scale value. For controlled clockwise operation. With German calibration certificate according to DIN EN ISO 6789.



**From 5 - 1,000 N·m.**  
For industry and automotive.

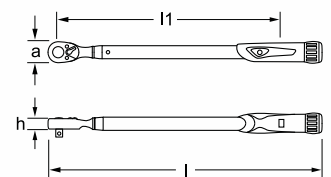

ART. CODE	mm / "	N·m	l1 mm	a mm	h mm	l mm	g
6175 0025	6.3 / 1/4	1 - 25	250	22.5	19.6	343	760
6175 0050	10 / 3/8	5 - 50	322	31.2	26.7	419	983
6175 0100	12.5 / 1/2	10 - 100	337	41.0	36.4	440	998
6175 0200	12.5 / 1/2	20 - 200	435	41.0	36.4	540	1360
6175 0340	12.5 / 1/2	56 - 340	538	41.0	36.4	640	1730
6175 0550	20 / 3/4	102 - 550	827	58.0	55.0	938	4500
6175 0750	20 / 3/4	140 - 750	1107	58.0	55.0	1218	5850
6175 1000	25 / 1	190 - 1000	1393	67.0	67.0	1508	7426
6175 5050	9x12 mm	5 - 50	322	31.2	26.7	378	886
6175 5100	9x12 mm	10 - 100	322	31.2	26.7	378	886
6175 5200	14x18 mm	20 - 200	435	41.0	36.4	490	1180
6175 5340	14x18 mm	56 - 340	538	41.0	36.4	595	1554

# Pneumatic Tools.

Still working when others have long given up.

## High Performance Impact Wrenches



- ✓ EXTREMELY LOW NOISE.
- ✓ EXTREMELY LIGHT.
- ✓ EXTREMELY POWERFUL.

**High-performance impact wrench** with outstanding technical features. Extremely powerful, light and quiet. Twin hammer clutch mechanism with 6-blades rotor. **Cold-insulated, non-slip handle.** Ultra light **composite housing.** One-hand switchover. Extremely **low vibration**, ideal for continuous operation. Low air consumption. Exhaust air guided downwards through the handle. Including coupler.

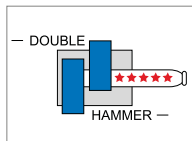

ART. CODE	N-m	N-m	dB(A)	U/min	l/min	m/s <sup>2</sup>	mm (")	kg		
7000 0001	12.9	1/2	1.490	813	83	7.000	113	6,8	10 (3/8)	1,9
7000 0002	20	3/4	3.200	1.898	90	5.500	198	10,2	13 (1/2)	3,3
7000 0003	25	1	3.200	1.898	90	5.500	198	10,2	13 (1/2)	3,4

## Impact Wrench „MiniMAX“



**High-performance impact wrench** with outstanding technical features. **Extremely small** (only 98 mm length), **extremely powerful 1.275 N·m loosening torque**, **light and low noise.** Jumbo hammer clutch. **Cold-insulated, non-slip handle.** Ultra light **composite housing.** One-hand switchover. Extremely **low vibration**, ideal for continuous operation. Low air consumption. Exhaust air guided downwards through the handle. Including coupler.

**1.275 N·m**

N-m	N-m	dB(A)	U/min	l/min	m/s <sup>2</sup>	mm (")	kg
1.275	678	94	10.000	164	7,3	10 (3/8)	1,27

ART. CODE 7000 0011 1/2

## High Performance Impact Wrench „FatCat“



**High-performance impact wrench** with outstanding technical features. Extremely powerful, light and quiet. Twin hammer clutch mechanism with 6-blades rotor. **Cold-insulated, non-slip handle.** Ultra light **composite housing.** Enormous **3.389 N·m** loosening torque. Only 96 dB (A) sound pressure level. Only 6.5 kg weight due to composite housing. With long anvil 180 mm (3"). Complete with side handle with mounting kit. Including coupler.

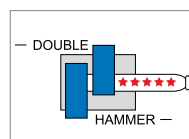

N-m	N-m	dB(A)	U/min	l/min	m/s <sup>2</sup>	mm (")	kg
3.389	2.441	96	6.000	282	12,9	13 (1/2)	7,3

ART. CODE 7000 0004 1





**4-255 mm.**

MATADOR's wide range of pneumatic tools: Impact sockets for industrial users from 4 to 255 mm. Not just hot air. Please take a look.



**Die Grinder, straight**



Collet 6 mm. With continuous power regulator for variable speed adjustment depending on the case of application. Including coupler.

dB(A)	U/min	l/min	m/s <sup>2</sup>	mm (°)	kg
79	20.000	113	0,46	10 (3/8)	0,7

ART. CODE  
7004 0001

**Micro Die Grinder**



Collet 3 mm. With continuous power regulator for variable speed adjustment depending on the case of application. Including coupler.

dB(A)	U/min	l/min	m/s <sup>2</sup>	mm (°)	kg
79	56.000	113	0,13	10 (3/8)	0,4

ART. CODE  
7004 0002

**Air Duster**



For cleaning and removing of swarfs and other particles. Anti-slip handle made of special plastic. Steel nozzle. Adjustable air volume. With hanging hole. Can be connected directly to air coupling.

dB(A)	U/min	l/min	bar	mm (°)	kg
88	15	300	5-8	10 (3/8)	0,1

ART. CODE  
7003 0001

**Impact Sockets, short type, 14 pcs**



12,5 mm  
1/2  
SMART DRIVE

Set of impact sockets, short type. With MATADOR SmartDrive<sup>2</sup>-Profile. Including safety rings and pins. In solid metal case with softfoam inlay.

ART. CODE	Size	Dimensions
7475	10 - 11 - 13 - 14 - 15 - 17 - 19 - 21 - 22 - 24 x 38 mm	
7499	1x 10 - 14 / 1x 15 - 32	

ART. CODE  
7475 9001

**Impact Sockets, long type, 13 pcs**



12,5 mm  
1/2  
SMART DRIVE

Set of impact sockets, long type. With MATADOR SmartDrive<sup>2</sup>-Profile. Including safety rings and pins. In solid metal case with softfoam inlay.

ART. CODE	Size	Dimensions
7481	10 - 13 - 15 - 17 - 18 - 19 - 21 - 22 - 24 x 78 mm	
7499	1x 10 - 14 - 1x 15 - 32	

ART. CODE  
7481 9001

**Impact Sockets, 17 pcs**



20 mm  
3/4  
SMART DRIVE

Set of impact sockets, short and long type. With MATADOR SmartDrive<sup>2</sup>-Profile. Including safety rings and pins. In solid metal case with softfoam inlay.

ART. CODE	Size	Dimensions
7575	17 - 19 - 22 - 24 - 27 - 30 - 32 x 50 mm	
7581	17 - 19 - 22 - 24 - 27 - 30 - 32 - 33 x 90 mm	
7599	1x 17 - 46 - 1x 17 - 46	

ART. CODE  
7575 9001

# Forged, not casted.

Manufactured for generations. Our classic.

■ Parallel Bench Vices

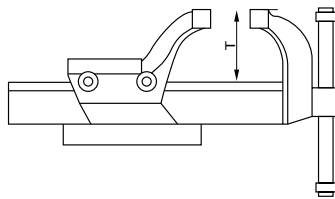
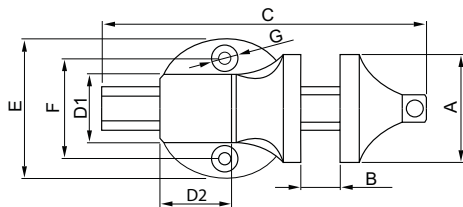

ART. CODE	A mm	T mm	B mm	D1 x D2 mm	C mm	E mm	F mm	G mm	kg
0817 0100	100	60	105	60 x 64	350	122	89	10,5	6,4
0817 0125	125	75	130	72 x 72	385	150	108	14,0	11,6
0817 0150	150	95	160	96 x 90	490	180	139	16,5	21,0

The classic for every workshop: Parallel bench vices **completely forged from high-quality steel** with **inductively hardened, polished and knurled jaws**. Big,

**hardened anvil**. Rolled, twin start trapezoid thread for precise and quick operation. **Integrated pipe-gripping jaws**. Spindle bearing protected against dirt and damage. Jaw opening capacity higher than jaw width for more comfortable operation. Delivery including rotary base.



With integrated pipe-gripping jaws.



Adjustable spindle guides for backlash-free operation.



Rotary base easy to fix and remove.



Steel arm easy to remove.

# MATADOR VDE tools.

















## Safety first.

### Electrician's Tool Kit in ABS case, 50 or 51 pcs

Tool kit for hybrid- and electric vehicle repair with 50 high quality tools, e.g.:

- Single ended spanners 8 - 24 mm
- Adjustable Wrenches
- 3-pc. set of pliers VDE with telephone pliers, combination pliers and side cutter
- 6-pc. set of screwdrivers VDE
- 12,5(1/2) Socket Set VDE with sockets 8-22 mm
- Hex Keys with T-Handle VDE
- In practical ABS hardshell case with extra storage space
- Optional with torque wrench VDE 20-100 N·m

Content:

ABS Case	8130	495 x 410 x 175 mm
	0131	8 - 9 - 10 - 11 - 12 - 13 - 14 - 15 - 16 - 17 - 18 - 19 - 20 - 21 - 22 - 23 - 24 mm
	0591	250 mm / 10"
	0532	160 mm / 6.1/4" VDE
	0585	170 mm / 6.3/4" VDE
	0500	205 mm / 8" VDE
	0616	0.4 x 2.5 x 75 - 0.8 x 4 x 100 1.0 x 5.5 x 125 mm VDE
	0656	PH 0 - PH 1 - PH 2 VDE
	4161	Lever Ratchet VDE
	4165	12,5(1/2) 125, 250 mm VDE
	4175	8 - 9 mm VDE
	4181	10 - 11 - 12 - 13 - 14 - 15 - 16 - 17 - 18 - 19 - 20 - 21 - 22 mm VDE
	0449	4 - 5 - 6 - 8 mm VDE
	4178	10 x 70 mm VDE
ART. CODE	8130 9550	
same as 8130 9550, additionally with torque wrench		
	6179	Torque Wrench 20 - 100 N·m VDE
ART. CODE	8130 9551	







MATADOR  
**Double  
Check**



### VDE Screwdriver Set, 6 pcs



6-pc. set of the most important VDE screwdrivers. With dual compound handles: Yellow, soft and anti-slip grip zone made of TPE plastic for secure hold with maximum pressure. Red, hard turning zone for quick working with low friction. High security through unique identification. **Insulated according to IEC 60900:2004.**

	0616	2.5 x 75 - 3.5 x 100 - 5.5 x 125 mm
	0635	0.5 x 3.0 mm
	0656	PH 1 - PH 2
ART. CODE	0681 1001	

1000 V







(without voltage tester)





### VDE Pliers Set, 3 pcs



3-pc. set of VDE pliers: Combination Pliers, Side Cutter and Telephone Pliers (straight or bent type).

Combination Pliers for cutting hard and soft wires. Inductively hardened cutting edges. Gripping zones for flat and round materials. **With nail and wire holder. Integrated ring spanner.** Power transmission with optimum leverage for easy and effortless work. High security through unique identification. **Insulated according to IEC 60900:2004.**

	0500	180 mm
	0532	180 mm
	0585	205 mm (straight)
ART. CODE	0501 1301	

	0500	180 mm
	0532	180 mm
	0586	205 mm (bent)
ART. CODE	0501 1302	



# Tool trolley ALLROUND.

The mobile workshop.



Stay mobile with the MATADOR premium trolley ALLROUND including 185-pc tool set.

Extremely robust, double-walled tool case with telescopic handle and smooth-running wheels. Comprehensive tool set „Best of MATADOR“.



Snap-lock telescopic handle.



Large, smooth-running wheels.



3K softGRIP

Innovative pliers set with 3C handles and many additional functions.



Including smartyBOX, our practical universal socket box.



Bottom can be divided by variable inserts.

Incl. smartyBox.  
**smartyBOX**

Content:

	0190	8 - 32 mm		0786	440 mm
	0442	1.5 - 10 mm L		0798	5 m
	0444	T10 - T50		0743	140 mm
	3K 0500	165 mm (6.1/2")		0745	250 mm
	3K 0530	165 mm (6.1/2")		0826	180 mm
	3K 0585	170 mm (6.3/4")		0762	Drill assortment HSS-R
	0556	240 mm (9.1/2")		0775	200 mm 5-tlg.
	0588	250 mm (10")		0782	290 x 40 mm
	0591	300 mm (12")		0784	1.000 g
	2K 0616	4 x 100 mm		0798	300 x 30 x 1,0 mm
	2K 0615	5,0 x 100 mm, 6,5 x 150 mm, 8,0 x 175 mm, 10,0 x 250 mm		0799	140 mm
	2K 0655	PH 1 x 80 mm, PH 2 x 100 mm PH 3 x 150 mm		0840	250 mm
	2K 0657	PZ 1 x 80 mm, PZ 3 x 150 mm		0843	5-tlg.
	0635	0,5 x 3,0 x 65 mm		4061	12,5 mm 1/2"
	0671	10 - 13 x 230 mm		4064	300 mm
	0700	35 mm		4065	125 - 250 mm
	0705	300 g, 500 g		4068	12,5 mm 1/2"
	0718	∅ 2 - 3 - 4 - 5 - 6 - 8 mm		4075	12,5 mm 1/2"
	0719	3 - 4 - 125 - 150 mm		2155	smartyBOX, 47 pcs

Outside dimensions:  
370 (h) x 485 (a) x 190 (b)

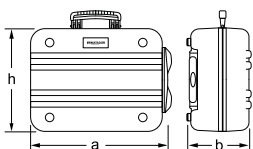

ART. CODE  
8132 0185



**Handy helpers.**  
The problem solvers from MATADOR.



## ■ Screw Extractor

**Loosens nearly all damaged, unhardened and even rusty screws** without thread repair tools. Since low-quality screws are becoming more prevalent, damaged and frayed screw heads are no longer an exception. Even the best screwdriver will be useless. The screw cannot be loosened. **The solution:** In most cases the screw can be loosened without employing laborious threading tools: Simply drive the tip of the the **MATADOR ScrewIT!** into the screw head by using a hammer, then unscrew the screw - done!

ART. CODE  
0770 0002

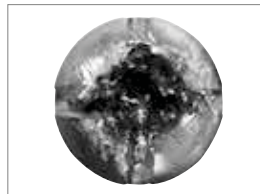

Perfect for damaged or rusted screw heads.



With impact cap for aimed release of hammer force.

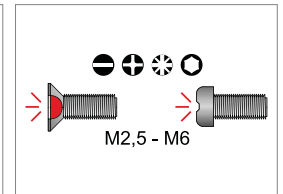

For all threads from M2,5 - M6.

**4** penny



## ■ Mini-Screwdriver 4in1

**Always at hand in urgent cases.**

Exceptionally practical pen screwdriver with 2 removable caps, each with a removable bit. 4 screwdrivers in one tool. Provides window for quick identification of the inserted bit. A perfect combination of precise technology and standard screwdriver. Suitable for glasses, mobile phones, remote controls, computers, toys, bicycles, cars and all kinds of repair in general.

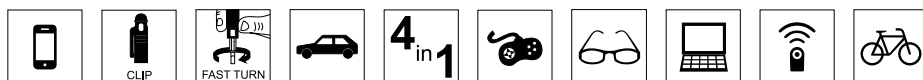

ART. CODE  
0664 0001

⊖ 1,5 - 3,0  
⊕ PH 00 - PH 0

**There are many tool cases in the market.**  
But only very few with high quality tools  
in a compact, full and uncompromising set.



**BlackBox.**



Shakeproof arrangement of the tools in soft foam inlays.



High functionality and easy-to-open intermediate plate.



High quality case „Made in Germany“ in a compact design.



Solid polypropylene construction with wide and rubberized handle.

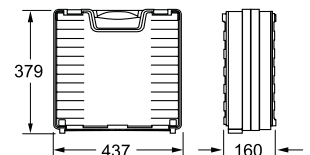

**The most important 125 high quality hand tools  
for work, home and hobby in one case.**  
Compact. Complete. Uncompromising.





4in1 ring ratchet spanners - the original.



High-quality ratchets, e.g. 12.5 (1/2) with torque exceeding 750 Nm.



Sockets in 5 star industrial quality with SUPER CHROM surface.



Innovative pliers set with 3KsoftGRIP handles and many special features.



High-quality screwdrivers set with ergonomic 2C handles.



Including smarty-BOX, our practical universal socket box.



For more information please use the QR-code.

## Everything included. Only high quality hand tools.



The MATADOR „BlackBox“ is a real surprise box. It contains everything a demanding and ambitious (hobby) mechanic needs for large and small repairs and maintenance. Thought-out compilation of tools, uncompromising quality and many multifunctional tools, e.g.:

- 4-pc pliers set with 3KsoftGRIP handles incl. allround side cutter for cutting, stripping, crimping and bending work
- 4in1 pocket screwdriver with pocket clip and the 4 most important screwdriver bits for slotted and cross-slotted (PH) screws incl. fine mechanics bits for glasses, mobile phone, keyboard, radio, etc.

- 4in1 ring ratchet spanner, suitable for 70% of all screwing work
- 6.3(1/4) smarty-BOX including the new reversible ratchet **Z90** with 90 teeth for the smallest gaps
- 2 hex key sets for hexagon socket and TORX screws with softGRIP holder for quick key removal

Shake-proof tool storage thanks to soft foam inlay that keeps all tools in place during transport. In well-designed and stable plastic case.

### Content:

		0184	10 - 13 - 17 - 19 mm			2061	90°
		0185	8 - 10 - 11 - 13 - 14 - 17 - 19 - 22 mm			2065	90° 1/4 50 mm
		0442	1.5 - 10 mm L			2075	6 - 7 - 8 - 9 - 10 - 11 13 mm
		0443	T10 - T50			2084	33 1/4
		0500	165 mm (6.1/2")			2085	
		0553	190 mm (7.1/2")			7026	3 - 3.5 - 4.5 - 5.5 - 6.5 x 25 mm, 4 - 6 x 75 mm
		0585	205 mm (8")			7027	PH 0 - PH 1 - PH 2 PH 2 - PH 3 x 25 mm PH 1 - PH 2 x 75 mm
		0556	240 mm (9.1/2")			7027	PZ 0 - PZ 1 - PZ 2 PZ 2 - PZ 3 x 25 mm
		0660	0.5 x 3.0 x 100 mm			7028	3 - 4 - 5 - 6 x 25 mm
		0615	0.8 x 5.0 x 100 mm, 1.0 x 5.5 x 125 mm, 1.2 x 6.5 x 150 mm			7033	T6 - T7 - T8 - T9 - T10 - T15 T20 - T25 - T27 - T30 T40 x 25 mm T25 - T30 x 75 mm
		0655	PH 0 x 60 mm, PH 1 x 80 mm PH 2 x 100 mm			7047	
		0635	0.5 x 3.0 x 65 mm			4061	90°
		0664	1.5 - 3.0 - PH 00 - PH 0			4064	300 mm
		0705	300 g			4065	125 - 250 mm
		0714	150 mm			4068	12.5 1/2
		0717	4 x 120 x 10 mm			4075	10 - 11 - 12 - 13 - 14 - 15 16 - 17 - 18 - 19 - 22 - 24 27 - 30 - 32 mm
		0718	∅ 3 - 4 - 5 - 6 mm			4085	
		0775	150 mm			4081	16 - 18 - 20.8 mm
		0784	270 g Neodym			7110	XL (9)
		0787	250 mm				
		0798	5 m				
		0828	170 mm				

ART. CODE  
4152 0001





Innovations and hot deals.  
2021 EN.



Stay tuned.



More MATADOR products?  
Browse or download our  
450-page main catalogue.



[www.matador.de](http://www.matador.de)

**MATADOR GmbH & Co. KG**

Morsbachtalstr. 17  
42855 Remscheid  
Germany

Tel. +49 2191 97 43 - 0  
Fax +49 2191 97 43 - 44

[sales@matador.de](mailto:sales@matador.de)

Your dealer:

Delivery without decoration. Technical specifications subject to modifications.  
No liability for printing errors. Please ask your local dealer.  
Valid until 28.02.2022.

Be a MATADOR.

